

Ventura

FORESTRY MACHINES



TARIFA DE PRECIOS
PRICE LIST
LISTE DE PRIX

37

Enero | January | Janvier 2020

Historia | History | Histoire

1953



Fundación de Ventura
Foundation of Ventura
Création de Ventura

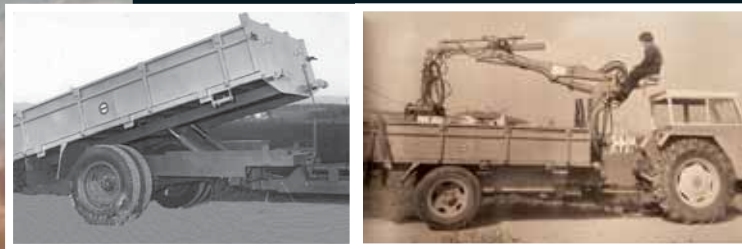

Los primeros remolques de tracción
The first traction trailers
La première remorques a traction



Las primeras series de cabrestantes
y desbrozadoras
The first series of winches and mowers
La première serie de treuils et broyeurs

1988



Nuevas instalaciones
New installations
Les nouveaux bâtiments



Fabricación
Manufacturing
Fabrication

2001



Exportación
Export
Exportation

Actualidad | News | Nouvelles



VENTURA MÁQUINAS FORESTALES, S.L. dispone en la actualidad de 8.000 m² cubiertos de forma que unos 4.800 m² se destinan a albergar la sección de fabricación propiamente dicha mientras que el resto está ocupada como almacén de maquinaria, servicio de repuestos, oficina técnica y oficinas.

Desde nuestros inicios se ha demostrado una voluntad de crecimiento. Hoy es una fábrica equipada con moderna maquinaria de producción y utillaje y un equipo altamente cualificado y experimentado.

Además, sometemos todos nuestros prototipos a las más extremas condiciones de funcionamiento para poder garantizar tanto el rendimiento como la máxima calidad y durabilidad de todos nuestros productos.

Cada año asistimos a diversas ferias muy especializadas del sector para exponer nuestra amplia gama de maquinaria.

VENTURA FORESTRY MACHINES, SL currently has 8000 m² of its total area. Approximately 4800 m² of this total area are used to house the manufacturing section. The rest is occupied for storage of machinery, spare parts service, technical office and offices.

From our beginnings we have demonstrated a desire to grow. Currently the factory is equipped with modern production machinery and tooling and a highly qualified and experienced team.

Also in Ventura, we submit all our prototypes to the most extreme operating conditions to ensure both the performance and the highest quality and durability of our products.

We attend every year to various highly specialized trade fairs of the sector to expose our wide range of machinery.

Ventura Máquinas Forestales, S.L. dispone de 8000 m² de la superficie total. De cette superficie totale, 4800 m² sont réservés à la fabrication des machines et 3200 m² pour le stockage, les pièces détachées, les services techniques et administratifs.

Depuis notre création nous avons démontré une volonté de croissance. Actuellement, notre usine est équipée de machines de production modernes, d'outillage et du personnel hautement qualifié et expérimenté.

En outre, dans notre entreprise, nous soumettons tous nos prototypes à des conditions d'exploitations extrêmes pour assurer le meilleur rendement, qualité et durabilité de nos produits.

Nous participons chaque année à différents salons et expositions spécialisés pour présenter notre large gamme de machines.





PRODUCTIVIDAD, POTENCIA,
FIABILIDAD Y EFICACIA

POWER PRODUCTIVITY, POWER,
RELIABILITY AND EFFICIENCY

PRODUCTIVITÉ, PUISSANCE,
FIABILITÉ ET EFFICACITÉ



Trituradoras Forestales

Forestry Mulcher | **Broyeurs Forestiers**

TFVJ	INDO	8
TFVJMF	AMUR	10
TFVJD	JURUA	12
TFVJMFD	VAAL	14
TFVJAM	LOMANI	16
TFVJC	CAUCA	18
TFV	VOLTA	20
TFVD	KASAR	22
TFVMF	JUBBA	24
TFVMFD	ELSA	26
TFMF	MADEIRA	28
VENTURA 80/42	GANGES	30



Trituradoras de piedras

Stone Crusher | **Broyeurs de Pierres**

TPV	TÍBER	34
TPVD	ARKANSAS	36
TFMFP	TER	38



Trituradora agrícolas

Agricultural mulcher | **Broyeurs agricoles**

ML	ELBA	42
MPT	URAL	44
TVA	LOIRE	46
TVAR	VISTULA	48
TSF	YUKON	50
TSF PTH	DUERO	52
M	KAMA	54
TSFE	MIN	56
TRIN	VOLGA	58
TRIN R	TURIA	60
TRIN R-E	SENA	62
TRIN PRO	CENIA	64
TGS	EBRO	66
TGSD	GRANDE	66
TAV	TAJO	68
TAV-O	LENA	70
TGDA	JAMES	72



Trituradoras Hidráulicas para excavadoras

Hydraulic Mulcher for excavators

Broyeurs Hydrauliques pour minipelles

TFVLHC	TARIM	76
TFVLIHML	KRISHNA	78
TFVLIHM	CABRIEL	80
TFVLMFH	TOCATINS	82
TFVNMFH	MEKONG	84
TFVJAH	LACHLAN	86
TFVJH	NAVIA	88
TFVJMFH	COLUMBIA	90
TFVH	DON	92
TFVMFH	TIGRE	94
TFMFH	AWASH	96



Trituradoras Hidráulicas para mini y palas cargadoras

Hydraulic Mulchers for mini and loaders

Broyeurs Hydrauliques pour mini et chargeurs

TFVLIHMC	INDUS	100
TFVLMFHC	MUGA	102
TFVJMFHCL	WASCANA	104
TFVJCHC	FLINDERS	106
TFVMFHC	YATA	108
TPVH	HAN	110
TFMFHC	KET	112



Desbrozadoras | Mower | **Girobroyeurs**

A	LENISSEI	116
AC	DONETS	118
ACB	MAYA	120
SF	SENEGAL	122
F	NILO	124
ACPL	CONGO	126
ACP	SEPIK	128
FR	RIN	130
F2NL	OBI	132
F2N	DRAA	134
ACL	AMAZONAS	136
DH	FLY	138
DLB 410	DADU	140
ADL	MILK	142
ADDL	CANADIAN	144
DL 650	CUMBERLAND	146



Astilladoras forestales | Forest Wood chipper

Déchiqueteuses forestières

ATV 150 GASOLINA	OHIO	150
ATV 155 DIESEL	PLATA	152
ATV 210 DIESEL	MISSOURI	154
ATV 170	ZAMBEZI	156
ATV 200	MACKENZIE	158
ATV 260	MISSISSIPPI	160
ATV 100	TENNESSEE	162
ATV 120	LIMPOPO	164
ATV 100 GASOLINA	HUDSON	166



Astilladora de tambor profesional | Profesional drum

Shredder | **Déchiqueteuse professionnelle**

ATV 400-650T	DARLING	168
--------------	---------	-----



Astilladora Trituradora Polivalente | Multipurpose

Shredder Chipper | **Déchiqueteuse polyvalente**

1320	CASTOR	170
------	--------	-----

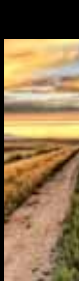

Hojas niveladoras | Graders | **Lames niveleuses**

NPH	PARANÁ	174
NPHL, NPM, NM	MURRAY	176

Ahoyadores | Post hole diggers | **Tarières**

A - B/M - B/H - C/M - C/H	DARIA	178
B.R.P.V	TAMESIS	180

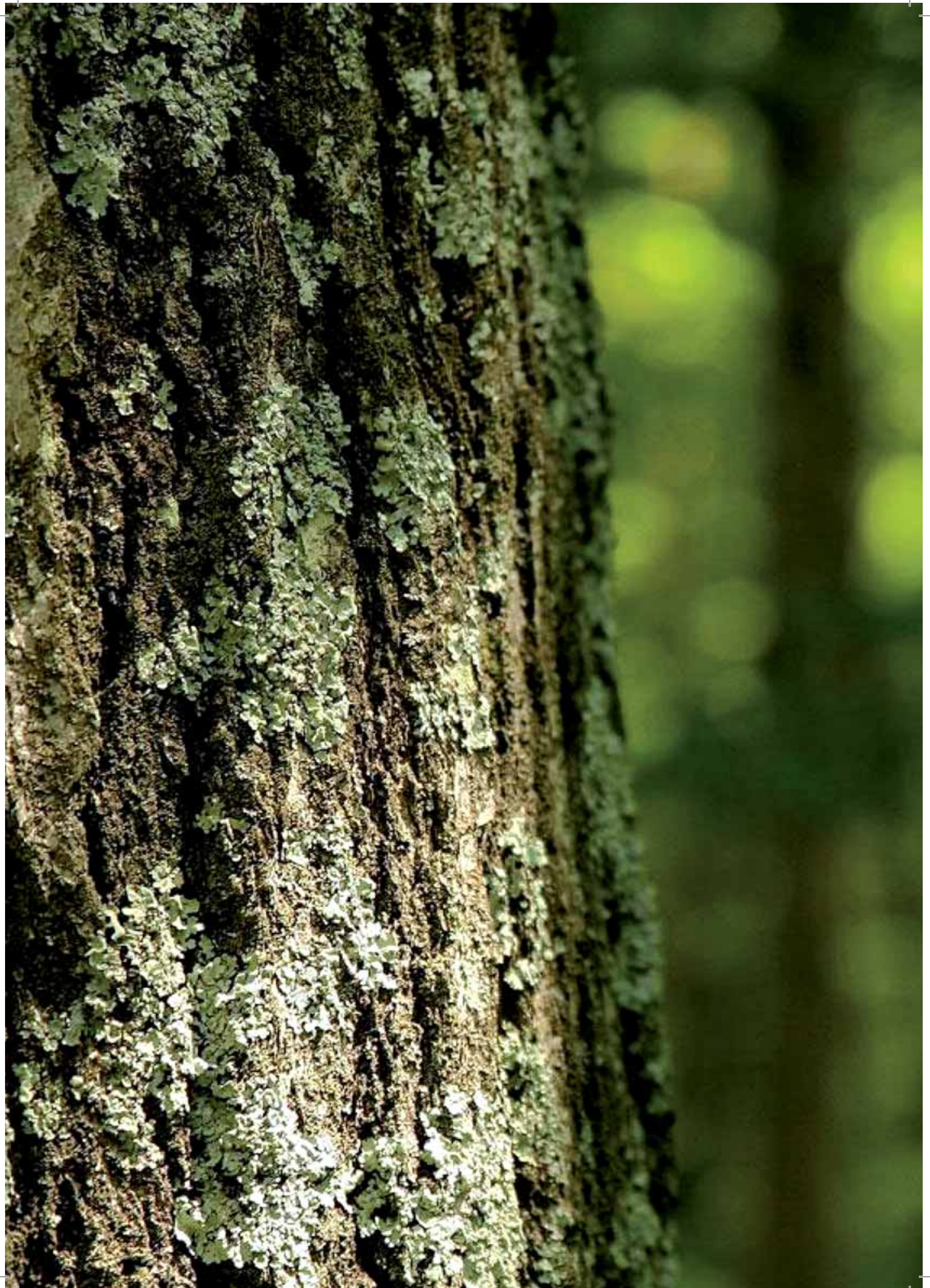



**Trituradoras Forestales
Forestry Mulcher
Broyeurs Forestiers**

TFVJ • INDO

TRITURADORA FORESTAL DE MARTILLOS MÓVILES 360° PARA TRONCOS HASTA Ø20CM

Trituradora forestal adecuada para arbustos y troncos de hasta 200 mm de diámetro así como para la trituración de madera, jardinería y agrícola.

Equipamiento: Estructura compacta y robusta hecha de chapa de alto límite elástico. Protecciones suficientes para salvaguardar la seguridad del operador. Fácil mantenimiento. Rueda libre incluida en el grupo multiplicador. Correas de transmisión SPBX dentadas. Puerta trasera hidráulica. Rotor porta-martillos muy robusto de acero antidesgaste con martillos oscilantes. Martillos forjados de larga vida y para trabajo pesado. Martillos de doble corte. Martillos de widia con punta de tungsteno. Patines de acero antidesgaste con una regulación de profundidad. Tercer punto de la categoría II. Transmisión (opcional). Barra de tumbado (opcional). Grupo reversible para el acoplamiento frontal del tractor (opcional). Rodillos trasero control (opcional).

FORESTRY MULCHER WITH 360° SWINGING HAMMERS FOR LOGS UP TO Ø20CM

Forestry mulcher TFVJ best suited for trunks up to 200 mm diameter and for all types of wood, gardening and agricultural uses.

Equipment: Compact and robust design made of high yield sheet plate. Sufficient protections to safeguard the operator's safety. Easy maintenance. Freewheel included in the gearbox. Timing belts SPBX. Hydraulic rear door. Very strong hammer holder shaft made of anti-wear steel plate with swinging hammers. Hammers forged for a long life and heavy work. Double cut hammers. Widia hammers with tungsten tip. Depth setting skids made of anti-wear steel. Third point category II. Transmission (optional). Rear pushing bar (optional). Reverse gearbox - so that the mulcher can be front-mounted (optional). Rear roller control (optional).

BROYEUR FORESTIER À MARTEUX OSCILLANTS 360° POUR TRONCS JUSQU'À Ø20CM

Broyeur forestier pour le broyage des branches et troncs d'arbres jusqu'à 200 mm de diamètre ainsi que pour le broyage de branchages, le débroussaillage et les travaux agricoles.

Équipement: Structure compacte et robuste en acier à Haute Limite Élastique. Protections suffisantes pour assurer la sécurité de l'opérateur. Facile d'entretien. Boîtier de renvoi d'angle à roue libre intégrée. Courroies de cardan SPBX dentées. Capot arrière à ouverture hydraulique. Arbre du rotor en acier anti-usure avec des marteaux oscillants. Marteaux forgés et traités pour de l'haute résistance et la durée. Marteaux de double coupe. Marteaux en widia avec pointe de tungstène. Patins en acier anti-usure réglage en hauteur. Le troisième point est de catégorie II. Cardan (en option). Barre arrière pour tomber les arbres (en option). Boîtier réversible pour l'attelage frontal (en option). Rouleaux arrière de control (en option).



		Modelos Model Modèle				
		TFVJ 130	TFVJ 150	TFVJ 180	TFVJ 200	TFVJ 225
	Revol. min RPM TPM	1000	1000	1000	1000	1000
	Ancho trabajo Working width Largeur travail	1300	1500	1800	2000	2250
	Medidas exteriores Outer dimensions Mesures extérieures	A cm. 146 B cm. 160 C cm. 110	146 180 110	146 210 110	146 230 110	146 255 110
	Ø cm. máx. tronco Ø cm. máx. trunc Ø cm. max. tronc	20	20	20	20	20
	Martillos móviles Swinging Hammers Marteaux oscillants	20	24	28	32	36
	Peso Weight Poids	1.008	1.110	1.250	1.354	1.458
	Nº Correas Num. Belts Num. Courroies	5	5	7	7	7
	Potencia tractor (min-max) Tractor power (min-max) Puissance tracteur (min-max)	60-130	70-130	70-130	75-130	90-130
	Ø mm. Rotor con martillos Ø mm. Rotor with hammers Ø mm. Rotor avec marteaux	455	455	455	455	455
	Categ. engan. Attach. category Categ. attelage	2a	2a	2a	2a	2a
	Velocidad avance km/h Forward speed km/h Vitesse avancement km/h	0-6	0-6	0-6	0-6	0-6
	TFT medidas PTO measures Prise force mesures	1 3/8 z=6	1 3/8 z=6	1 3/8 z=6	1 3/8 z=6	1 3/8 z=6
	Protección delantera Front guard Protection frontal	Cadena doble Double chain Chaîne double				

* El Peso incluye la barra de tumbado | The weight includes the rear pushing bar | **Le poids contient la barre arrière**



PRECIO | PRICE | PRIX

		Martillos de widia Widia hammers Marteaux en widia
TFVJ 130	12.655,00€	13.940,00€
TFVJ 150	13.068,00€	14.615,00€
TFVJ 180	13.505,00€	15.315,00€
TFVJ 200	13.995,00€	16.075,00€
TFVJ 225	14.830,00€	17.140,00€

Equipamiento de serie | Standard equipment | Équipement standard

- Rueda libre incluida en el grupo | Freewheel gearbox | **Boîtier à roue libre**
- Chapa antidesgaste rotor | Hammer holder shaft made of anti-wear steel
Rotor en acier anti-usure
- Puerta trasera hidráulica | Hydraulic rear door | **Capot arrière à ouverture hydraulique**

Opciones | Options | Options

Transmision Transmission Cardan	392,00€
Barra de tumbado trasera Rear pushing bar Barre arrière pour tomber les arbres	700,00€
Grupo reversible (para acoplamiento frontal tractor) Reverse gearbox Boîtier reversible	502,00€
Rodillo trasero de control Rear roller control Rouleaux arrière de control	1.130,00€

TFVJMF • AMUR

TRITURADORA FORESTAL DE MARTILLOS FIJOS CON PUNTA DE WIDIA PARA TRONCOS DE HASTA Ø20CM

Trituradora forestal adecuada para arbores y troncos de hasta 200 mm de diámetro así como para la trituración de madera, jardinería y agrícola.

Equipamiento: Estructura compacta y robusta hecha de chapa de alto límite elástico. Protecciones suficientes para salvaguardar la seguridad del operador. Fácil mantenimiento. Rueda libre incluida en el grupo multiplicador. Correas de transmisión SPBX dentadas. Puerta trasera hidráulica. Martillos fijos de widia. Patines de acero antidesgaste con una regulación de profundidad. Tercer punto de la categoría II. Transmisión (opcional). Barra de tumbado (opcional). Patines para trabajo de profundidad (opcional). Grupo reversible para el acoplamiento frontal del tractor (opcional). Rodillos trasero control (opcional).

FORESTRY MULCHER WITH FIXED WIDIA HAMMERS FOR LOGS UP TO Ø20CM

Forestry mulcher best suited for trunks up to 200 mm diameter and for all types of wood, gardening and agricultural uses.

Equipment: Compact and robust design made of high yield sheet plate. Sufficient protections to safeguard the operator's safety. Easy maintenance. Freewheel included in the gearbox. Timing belts SPBX. Hydraulic rear door. Fixed widia hammers. Depth setting skids made of anti-wear steel. Third point category II. Transmission (optional). Rear pushing bar (optional). Skids for depth work. (optional). Reverse gearbox - so that the mulcher can be front-mounted (optional). Rear roller control. (optional).

BROYEUR FORESTIER À MARTEUX FIXES EN WIDIA POUR TRONCS JUSQU'À Ø20CM

Broyeur forestier pour le broyage des branches et troncs d'arbres jusqu'à 200 mm diamètre ainsi que pour le broyage de bois, jardinage et exploitation agricole.

Équipement: Structure compacte et robuste en acier à Haute Limite Elastique. Protections suffisantes pour assurer la sécurité de l'opérateur. Facile d'entretien. Boîtier de renvoi d'angle à roue libre intégrée. Courroies de cardan SPBX dentées. Capot arrière à ouverture hydraulique. Marteaux fixes en widia. Patins en acier anti-usure réglage en hauteur. Le troisième point est de catégorie II. Cardan (en option). Barre arrière pour tomber les arbres (en option). Patins pour travail en profondeur (en option). Boîtier réversible pour l'attelage frontal (en option). Rouleaux arrière de control (en option).

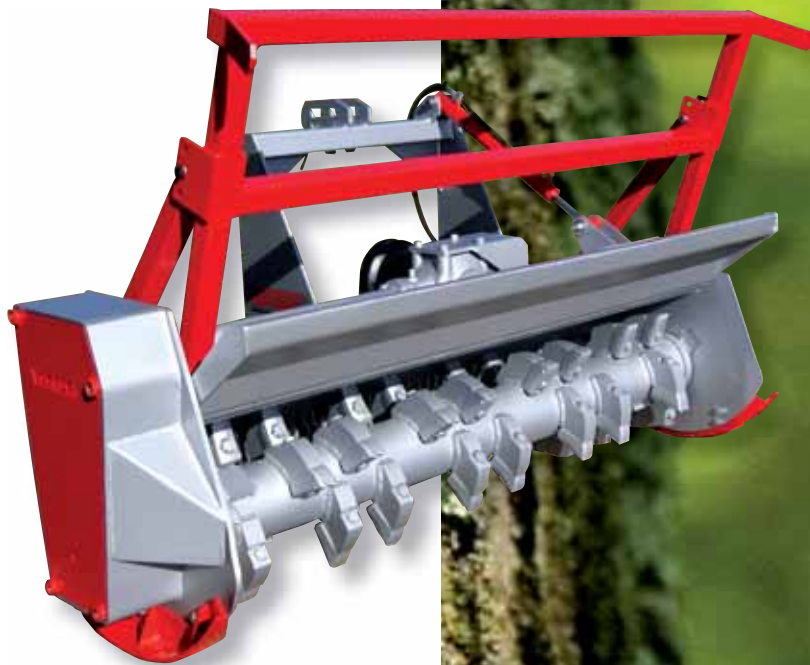

		Modelos		Model	Modèle	
		TFVJMF 130	TFVJMF 150	TFVJMF 180	TFVJMF 200	TFVJMF 225
	Revol. min RPM TPM	1000	1000	1000	1000	1000
	Ancho trabajo Working width Largeur travail	1300	1500	1800	2000	2250
	Medidas exteriores Outer dimensions Mesures extérieures	A cm. 146 B cm. 160 C cm. 110	146 180 110	146 210 110	146 230 110	146 255 110
	Profundidad cm Depth cm Profondeur cm	7	7	7	7	7
	Ø cm. máx. tronco Ø cm. máx. trunc Ø cm. max. tronc	20	20	20	20	20
	Martillos fijos Vidia Fixed Vidia Hammers Marteaux fixes Vidia	20+2	24+2	28+2	32+2	34+2
	Peso Weight Poids	880	992	1.094	1.196	1.298
	Nº Correas Num. Belts Num. Courroies	5	7	7	7	7
	Potencia tractor (min-max) Tractor power (min-max) Puissance tracteur (min-max)	60-130	70-130	70-130	75-130	90-130
	Ø mm. Rotor con martillos Ø mm. Rotor with hammers Ø mm. Rotor avec marteaux	460	460	460	460	460
	Categ. engan. Attach. category Categ. attelage	2a	2a	2a	2a	2a
	Velocidad avance km/h Forward speed km/h Vitesse avancement km/h	0-6	0-6	0-6	0-6	0-6
	TFT medidas PTO measures Prise force mesures	1 3/8 z=6	1 3/8 z=6	1 3/8 z=6	1 3/8 z=6	1 3/8 z=6
	Protección delantera Front guard Protection frontal	Cadena doble Double chain Chaîne double				

* El Peso incluye la barra de tumbado | The weight includes the rear pushing bar | **Le poids contient la barre arrière**



PRECIO | PRICE | PRIX

TFVJMF 130	13.260,00€
TFVJMF 150	14.540,00€
TFVJMF 180	15.850,00€
TFVJMF 200	16.850,00€
TFVJMF 225	17.850,00€

Equipamiento de serie | Standard equipment | Équipement standard

- Rueda libre incluida en el grupo | Freewheel gearbox | **Boîtier à roue libre**
- Puerta trasera hidráulica | Hydraulic rear door | **Capot arrière à ouverture hydraulique**

Opciones | Options | Options

Transmisión con limitador Transmission with limiter Avec limiteur Bondioli Pavesi	1.145,00€
Transmisión Transmission Transmission	392,00€
Barra de tumbado trasera Rear pushing bar Barre arrière pour tomber les arbres	700,00€
Grupo reversible (para acoplamiento frontal tractor) Reverse gearbox Boîtier réversible	502,00€
Patines para trabajo de profunda Skids for depth work Patins pour travail en profondeur	205,00€
Rodillo trasero de control Rear roller control Rouleaux arrière de control	1.130,00€

TFVJD • JURUA

TFVJD - TRITURADORA FORESTAL DE MARTILLOS MÓVILES 360° DOBLE TRACCIÓN PARA TRONCOS DE HASTA Ø25CM

Trituradora forestal adecuada para arbustos y troncos de hasta 250 mm de diámetro así como para la trituración de madera, jardinería y agrícola.

Equipamiento: Estructura compacta y robusta hecha de chapa de alto límite elástico. Los modelos TFVJD incorporan doble transmisión por correas. Protecciones suficientes para salvaguardar la seguridad del operador. Fácil mantenimiento. Rueda libre incluida en el grupo multiplicador. Correas de transmisión SPBX dentadas. Puerta trasera hidráulica. Rotor portamartillos muy robusto de acero antidesgaste con martillos oscilantes. Martillos forjados de larga vida y para trabajo pesado. Martillos de doble corte. Martillos de widia con punta de tungsteno. Patines de acero antidesgaste con una regulación de profundidad. Tercer punto de la categoría II. Transmisión (opcional). Barra de tumbado (opcional). Rodillos trasero control (opcional).

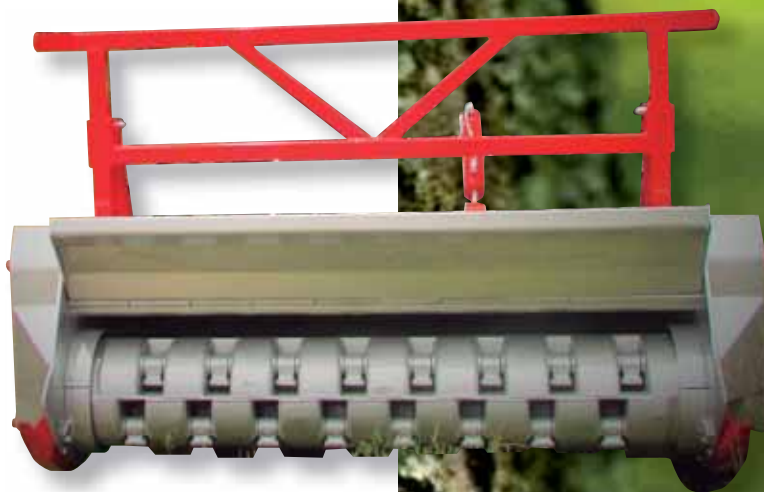

TFVJD - FORESTRY MULCHER WITH 360° SWINGING HAMMERS AND DOUBLE DRIVE FOR LOGS UP TO Ø25CM

Forestry mulcher TFVJ best suited for trunks up to 250 mm diameter and for all types of wood, gardening and agricultural uses.

Equipment: Compact and robust design made of high yield sheet plate. TFVJD models feature double drive belt system. Sufficient protections to safeguard the operator's safety. Easy maintenance. Freewheel included in the gearbox. Timing belts SPBX. Hydraulic rear door. Very strong hammer holder shaft made of anti-wear steel plate with swinging hammers. Hammers forged for a long life and heavy work. Double cut hammers. Widia hammers with tungsten tip. Depth setting skids made of anti-wear steel. Third point category II. Transmission (optional). Rear pushing bar (optional). Rear roller control. (optional).

TFVJD - BROYEUR FORESTIER À MARTEUX OSCILLANTS 360° AVEC DOUBLE ENTRAÎNEMENT POUR TRONCS JUSQU'À Ø25CM

Broyeur forestier pour le broyage des branches et troncs d'arbres jusqu'à 250 mm diamètre ainsi que pour le broyage de bois, jardinage et exploitation agricole.

Équipement: Structure compacte et robuste en acier à Haute Limite Elastique. Les modèles TFVJD disposent de double entraînement pour courroie. Protections suffisantes pour assurer la sécurité de l'opérateur. Facile d'entretien. Boîtier de renvoi d'angle à roue libre intégrée. Courroies de cardan SPBX dentées. Capot arrière à ouverture hydraulique. Arbre du rotor en acier anti-usure avec des marteaux oscillants. Marteaux forgés et traités pour de l'haute résistance et la durée. Marteaux de double coupe. Marteaux en widia avec pointe de tungstène. Patins en acier anti-usure réglage en hauteur. Le troisième point est de catégorie II. Cardan (en option). Barre arrière pour tomber les arbres (en option). Rouleaux arrière de control (en option).



		Modelos	Model	Modèle
		TFVJD 200	TFVJD 225	TFVJD 250
	Revol. min RPM TPM	1000	1000	1000
	Ancho trabajo Working width Largeur travail	2000	2250	2500
	Medidas exteriores Outer dimensions Mesures extérieures	A cm. 146 B cm. 236 C cm. 110	146 261 110	146 286 110
	Ø cm. máx. tronco Ø cm. máx. trunc Ø cm. max. tronc	25	25	25
	Martillos móviles Swinging Hammers Marteaux oscillants	32	36	40
	Peso Weight Poids	1.506	1.608	1.710
	Nº Correas Num. Belts Num. Courroies	10	10	10
	Potencia tractor (min-max) Tractor power (min-max) Puissance tracteur (min-max)	75-150	90-160	100-160
	Ø mm. Rotor con martillos Ø mm. Rotor with hammers Ø mm. Rotor avec marteaux	455	455	455
	Categ. engan. Attach. category Categ. attelage	2a	2a	2a
	Velocidad avance km/h Forward speed km/h Vitesse avancement km/h	0-6	0-6	0-6
	TFT medidas PTO measures Prise force mesures	1 3/4 z=6	1 3/4 z=6	1 3/4 z=6
	Protección delantera Front guard Protection frontal	Cadena doble Double chain Chaîne double		

* El Peso incluye la barra de tumbado | The weight includes the rear pushing bar | **Le poids contient la barre arrière**

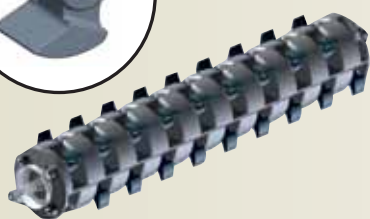

PRECIO | PRICE | **PRIX**

		Martillos de widia Widia hammers Marteaux en widia
TFVJD 200	17.155,00€	19.235,00€
TFVJD 225	17.985,00€	20.300,00€
TFVJD 250	19.805,00€	22.510,00€

Equipamiento de serie | Standard equipment | **Équipement standard**

- Rueda libre incluida en el grupo | Freewheel gearbox | **Boîtier à roue libre**
- Chapa antidesgaste rotor | Hammer holder shaft made of anti-wear steel
Rotor en acier anti-usure
- Puerta trasera hidráulica | Hydraulic rear door | **Capot arrière à ouverture hydraulique**

Opciones | Options | **Options**

Transmisión Transmission Cardan	392,00€
Barra de tumbado trasera Rear pushing bar Barre arrière pour tomber les arbres	700,00€
Rodillo trasero de control Rear roller control Rouleaux arrière de control	1.130,00€

TFVJMFD • VAAL

TFVJMFD - TRITURADORA FORESTAL DE MARTILLOS FIJOS CON PUNTA DE WIDIA DOBLE TRACCIÓN PARA TRONCOS HASTA Ø25CM

Trituradora forestal adecuada para arbustos y troncos de hasta 250 mm de diámetro así como para la trituración de madera, jardinería y agrícola.

Equipamiento: Estructura compacta y robusta hecha de chapa de alto límite elástico. Los modelos TFVJMFD incorporan doble transmisión por correas. Protecciones suficientes para salvaguardar la seguridad del operador. Fácil mantenimiento. Rueda libre incluida en el grupo multiplicador. Correas de transmisión SPBX dentadas. Puerta trasera hidráulica. Martillos fijos de widia. Patines de acero antidesgaste con una regulación de profundidad. Tercer punto de la categoría II. Transmisión (opcional). Barra de tumbado (opcional). Patines para trabajo de profundidad (opcional). Rodillos trasero control (opcional).

TFVJMFD - FORESTRY MULCHER WITH FIXED WIDIA HAMMERS AND DOUBLE DRIVE FOR LOGS UP TO Ø25CM

Forestry mulcher best suited for trunks up to 250 mm diameter and for all types of wood, gardening and agricultural uses.

Equipment: Compact and robust design made of high yield sheet plate. TFVJMFD models feature double drive belt system. Sufficient protections to safeguard the operator's safety. Easy maintenance. Freewheel included in the gearbox. Timing belts SPBX. Hydraulic rear door. Fixed widia hammers. Depth setting skids made of anti-wear steel. Third point category II. Transmission (optional). Rear pushing bar (optional). Skids for depth work. (optional). Rear roller control. (optional)

TFVJMFD - BROYEUR FORESTIER À MARTEUX FIXES EN WIDIA AVEC DOUBLE ENTRAÎNEMENT

Broyeur forestier pour le broyage des branches et troncs d'arbres jusqu'à 250 mm diamètre ainsi que pour le broyage de bois, jardinage et exploitation agricole.

Équipement: Structure compacte et robuste en acier à Haute Limite Elastique. Les modèles TFVJMFD disposent de double entraînement pour courroie. Protections suffisantes pour assurer la sécurité de l'opérateur. Facile d'entretien. Boîtier de renvoi d'angle à roue libre intégrée. Courroies de cardan SPBX dentées. Capot arrière à ouverture hydraulique. Marteaux fixes en widia. Patins en acier anti-usure réglage en hauteur. Le troisième point est de catégorie II. Cardan (en option). Barre arrière pour tomber les arbres (en option). Patins pour travail en profondeur (en option). Rouleaux arrière de control (en option).



		Modelos Model Modèle		
		TFVJMFD 200	TFVJMFD 225	TFVJMFD 250
	Revol. min RPM TPM	1000	1000	1000
	Ancho trabajo Working width Largeur travail	2000	2250	2500
	Medidas exteriores Outer dimensions Mesures extérieures	A cm. 146 B cm. 236 C cm. 110	146 261 110	146 286 110
	Profundidad cm Depth cm Profondeur cm	7	7	7
	Ø cm. máx. tronco Ø cm. máx. trunc Ø cm. max. tronc	25	25	25
	Martillos fijos Vidia Fixed Widia Hammers Marteaux fixes Widia	32+2	34+2	38+2
	Peso Weight Poids	1344	1446	1548
	Nº Correas Num. Belts Num. Courroies	10	10	10
	Potencia tractor (min-max) Tractor power (min-max) Puissance tracteur (min-max)	75-150	90-160	100-160
	Ø mm. Rotor con martillos Ø mm. Rotor with hammers Ø mm. Rotor avec marteaux	460	460	460
	Categ. engan. Attach. category Categ. attelage	2a	2a	2a
	Velocidad avance km/h Forward speed km/h Vitesse avancement km/h	0-6	0-6	0-6
	TFT medidas PTO measures Prise force mesures	1 3/4 z=6	1 3/4 z=6	1 3/4 z=6
	Protección delantera Front guard Protection frontal	Cadena doble Double chain Chaîne double		

* El Peso incluye la barra de tumbado | The weight includes the rear pushing bar | **Le poids contient la barre arrière**

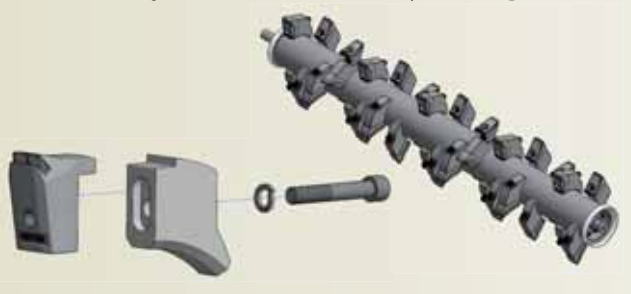

PRECIO | PRICE | PRIX

TFVJMFD 200	21.055,00€
TFVJMFD 225	21.700,00€
TFVJMFD 250	23.650,00€

Equipamiento de serie | Standard equipment | Équipement standard

- Rueda libre incluida en el grupo | Freewheel gearbox | **Boîtier à roue libre**
- Puerta trasera hidráulica | Hydraulic rear door | **Capot arrière à ouverture hydraulique**

Opciones | Options | Options

Transmisión con limitador Transmission with limiter Avec limiteur Bondioli Pavesi	1.145,00€
Transmisión Transmission	392,00€
Barra de tumbado trasera Rear pushing bar Barre arrière pour tomber les arbres	700,00€
Patines para trabajo de profundidad Skids for depth work Patins pour travail en profondeur	205,00€
Rodillo trasero de control Rear roller control Rouleaux arrière de control	1.130,00€

TFVJAM • LOMANI

TFVJAM - TRITURADORA SEMIFORESTAL DE MARTILLOS OSCILANTES 360° PARA TRONCOS DE HASTA Ø18CM

Trituradora semiforestal adecuada para arbustos para arbustos y troncos de hasta 180 mm de diámetro así como para la trituración de madera, jardinería y agrícola.

Equipamiento: Estructura compacta y robusta hecha de chapa de alto límite elástico. Protecciones suficientes para salvaguardar la seguridad del operador. Fácil mantenimiento. Rueda libre incluida en el grupo multiplicador. Correas de transmisión SPBX dentadas. Puerta trasera hidráulica. Martillos oscilantes. Patines de acero anti-desgaste con una regulación de profundidad. Tercer punto de la categoría II. Transmisión (opcional). Barra de tumbado (opcional). Grupo reversible para el acoplamiento frontal del tractor (opcional). Rodillos trasero control (opcional).

TFVJAM - SEMI-FORESTRY MULCHER WITH 360° OSCILLATING HAMMERS FOR LOGS UP TO Ø18CM

Semi-forestry mulcher best suited for trunks up to 180 mm diameter and for all types of wood, gardening and agricultural uses.













Equipment: Compact and robust design made of high yield sheet plate. Sufficient protections to safeguard the operator's safety. Easy maintenance. Freewheel included in the gearbox. Timing belts SPBX. Hydraulic rear door. Oscillating Hammers. Depth setting skids made of anti-wear steel. Third point category II. Transmission (optional). Rear pushing bar (optional). Reverse gearbox - so that the mulcher can be front-mounted (optional). Rear roller control (optional)

TFVJAM - BROYEUR SEMI-FORESTIER À MARTEUX OSCILLANTS 360° POUR TRONCS JUSQU'À Ø18CM

Broyeur semi-forestier pour le broyage des branches et troncs d'arbres jusqu'à 180 mm diamètre ainsi que pour le broyage de branchages, le débroussaillage et les travaux agricoles.

Équipement: Structure compacte et robuste en acier à Haute Limite Elastique. Protections suffisantes pour assurer la sécurité de l'opérateur. Facile d'entretien. Boîtier de renvoi d'angle à roue libre intégrée. Courroies de cardan SPBX dentées. Capot arrière à ouverture hydraulique. Marteaux oscillants. Patins en acier anti-usure réglage en hauteur. Le troisième point est de catégorie II. Cardan (en option). Barre arrière pour tomber les arbres (en option). Boîtier réversible pour l'attelage frontal (en option). Rouleaux arrière de control (en option).



		Modelos Model Modèle				
		TFVJAM 130	TFVJAM 150	TFVJAM 180	TFVJAM 200	TFVJAM 225
	Revol. min RPM TPM	540	540	540	540	540
	Ancho trabajo Working width Largeur travail	1300	1500	1800	2000	2250
	Medidas exteriores Outer dimensions Mesures extérieures	A cm. 146 B cm. 160 C cm. 110	146 180 110	146 210 110	146 230 110	146 255 110
	Ø cm. máx. tronco Ø cm. máx. trunc Ø cm. max. tronc	18	18	18	18	18
	Martillos móviles Swinging Hammers Marteaux oscillants	8	9	10	11	12
	Peso Weight Poids	943	1040	1182	1284	1385
	Nº Correas Num. Belts Num. Courroies	5	5	5	5	5
	Potencia tractor (min-max) Tractor power (min-max) Puissance tracteur (min-max)	60-130	70-130	70-130	75-130	90-130
	Ø mm. Rotor con martillos Ø mm. Rotor with hammers Ø mm. Rotor avec marteaux	435	435	435	435	435
	Categ. engan. Attach. category Categ. attelage	2a	2a	2a	2a	2a
	Velocidad avance km/h Forward speed km/h Vitesse avancement km/h	0-6	0-6	0-6	0-6	0-6
	TFT medidas PTO measures Prise force mesures	1 3/8 z=6	1 3/8 z=6	1 3/8 z=6	1 3/8 z=6	1 3/8 z=6
	Protección delantera Front guard Protection frontal	Cadena doble Double chain Chaîne double				

* El Peso incluye la barra de tumbado | The weight includes the rear pushing bar | **Le poids contient la barre arrière**

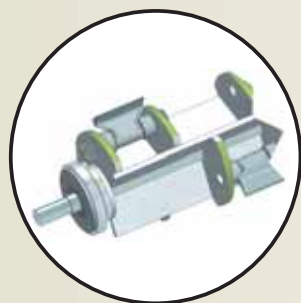

PRECIO | PRICE | PRIX

TFVJAM 130	11.640,00€
TFVJAM 150	12.020,00€
TFVJAM 180	12.425,00€
TFVJAM 200	12.875,00€
TFVJAM 225	13.650,00€

Equipamiento de serie | Standard equipment | Équipement standard

- Rueda libre incluida en el grupo | Freewheel gearbox | **Boîtier à roue libre**
- Puerta trasera hidráulica | Hydraulic rear door | **Capot arrière à ouverture hydraulique**

Opciones | Options | Options

Transmision Transmission Cardan	392,00€
Barra de tumbado trasera Rear pushing bar Barre arrière pour tomber les arbres	700,00€
Grupo reversible (para acoplamiento frontal tractor) Reverse gearbox Boîtier reversible	502,00€
Rodillo trasero de control Rear roller control Rouleaux arrière de control	1.130,00€

TFVJC • CAUCA

TRITURADORA FORESTAL DE MARTILLOS RÍGIDOS PARA TRONCOS DE HASTA Ø20CM

Trituradora forestal adecuada para arbustos y troncos de hasta 200 mm de diámetro así como para la trituración de madera, jardinería y agrícola.

Equipamiento: Estructura compacta y robusta hecha de chapa de alto límite elástico. Protecciones suficientes para salvaguardar la seguridad del operador. Fácil mantenimiento. Rueda libre incluida en el grupo multiplicador. Correas de transmisión SPBX dentadas. Puerta trasera hidráulica. Patines de acero antidesgaste con una regulación de profundidad. Tercer punto de la categoría II. Transmisión (opcional). Barra de tumbado (opcional). Patines para trabajo de profundidad (opcional). Grupo reversible para el acoplamiento frontal del tractor (opcional). Rodillos trasero control (opcional).

FORESTRY MULCHER WITH RIGID HAMMERS FOR LOGS UP TO Ø20CM

Forestry mulcher best suited for trunks up to 200 mm diameter and for all types of wood, gardening and agricultural uses.













Equipment: Compact and robust design made of high yield sheet plate. Sufficient protections to safeguard the operator's safety. Easy maintenance. Freewheel included in the gearbox. Timing belts SPBX. Hydraulic rear door. Depth setting skids made of anti-wear steel. Third point category II. Transmission (optional). Rear pushing bar (optional). Skids for depth work. (optional). Reverse gearbox - so that the mulcher can be front-mounted (optional). Rear roller control. (optional).

BROYEUR FORESTIER À MARTEUX RIGIDES POUR TRONCS JUSQU'À Ø20CM

Broyeur forestier pour le broyage des branches et troncs d'arbres jusqu'à 200 mm diamètre ainsi que pour le broyage de bois, jardinage et exploitation agricole.

Équipement: Structure compacte et robuste en acier à Haute Limite Élastique. Protections suffisantes pour assurer la sécurité de l'opérateur. Facile d'entretien. Boîtier de renvoi d'angle à roue libre intégrée. Courroies de cardan SPBX dentées. Capot arrière à ouverture hydraulique. Patins en acier anti-usure réglage en hauteur. Le troisième point est de catégorie II. Cardan (en option). Barre arrière pour tomber les arbres (en option). Patins pour travail en profondeur (en option). Boîtier réversible pour l'attelage frontal (en option). Rouleaux arrière de control (en option).



	Modelos Model Modèle				
	TFVJC 130	TFVJC 150	TFVJC 180	TFVJC 200	TFVJC 225
 Revol. min RPM TPM	1000	1000	1000	1000	1000
 Ancho trabajo Working width Largeur travail	1300	1500	1800	2000	2250
 Medidas exteriores Outer dimensions Mesures extérieures	A cm. 146 B cm. 160 C cm. 110	146 180 110	146 210 110	146 230 110	146 255 110
 ø cm. máx. tronco ø cm. máx. trunc ø cm. max. tronc	20	20	20	20	20
 Martillos rígidos Rigid hammers Marteaux rigides	15	21	27	33	39
 Peso Weight Poids	880	992	1.094	1.196	1.298
 N° Correas Num. Belts Num. Courroies	5	7	7	7	7
 Potencia tractor (min-max) Tractor power (min-max) Puissance tracteur (min-max)	60-130	70-130	70-130	75-130	90-130
 ø mm. Rotor con martillos ø mm. Rotor with hammers ø mm. Rotor avec marteaux	460	460	460	460	460
 Categ. engan. Attach. category Categ. attelage	2a	2a	2a	2a	2a
 Velocidad avance km/h Forward speed km/h Vitesse avancement km/h	0-6	0-6	0-6	0-6	0-6
 TFT medidas PTO measures Prise force mesures	1 3/8 z=6	1 3/8 z=6	1 3/8 z=6	1 3/8 z=6	1 3/8 z=6
 Protección delantera Front guard Protection frontal	Cadena doble Double chain Chaîne double				

* El peso incluye la barra de tumbado | The weight includes the rear pushing bar | **Le poids contient la barre arrière**



PRECIO | PRICE | **PRIX**

TFVJC 130	13.610,00€
TFVJC 150	14.910,00€
TFVJC 180	16.230,00€
TFVJC 200	17.255,00€
TFVJC 225	18.270,00€

Equipamiento de serie | Standard equipment | **Équipement standard**

- Rueda libre incluida en el grupo | Freewheel gearbox | **Boîtier à roue libre**
- Puerta trasera hidráulica | Hydraulic rear door | **Capot arrière à ouverture hydraulique**

Opciones | Options | **Options**

Transmisión con limitador Transmission with limiter Avec limiteur Bondioli Pavesi	1.145,00€
Barra de tumbado trasera Rear pushing bar Barre arrière pour tomber les arbres	700,00€
Grupo reversible (para acoplamiento frontal tractor) Reverse gearbox Boîtier réversible	502,00€

TFV • VOLTA

TFV - TRITURADORA FORESTAL DE MARTILLOS MÓVILES 360° PARA TRONCOS DE HASTA Ø30CM

Trituradora forestal adecuada para arbustos y troncos de hasta 300 mm de diámetro así como para la trituración de madera, jardinería y agrícola.

Equipamiento: Construcción muy robusta para poder soportar los esfuerzos más intensos con chapa de alto límite elástico. Protecciones suficientes para salvaguardar la seguridad del operador. Fácil mantenimiento. Rueda libre incluida en el grupo multiplicador. Correas de transmisión SPBX dentadas. Puerta trasera hidráulica. Rotor portamartillos muy robusto de acero anti-desgaste con martillos móviles/oscilantes 360°. Patines de acero anti-desgaste con una regulación de profundidad. Tercer punto de la categoría II. Transmisión (opcional). Barra de tumbado (opcional). Tercer punto hidráulico. (opcional). Grupo reversible para el acoplamiento frontal del tractor (opcional). Embrague centrífugo de puesta en marcha (opcional). Rastrillo puerta trasera (opcional)

TFV - FORESTRY MULCHER WITH 360° SWINGING HAMMERS FOR LOGS UP TO Ø30CM

Forestry mulcher best suited for trunks up to 300 mm diameter and for all types of wood, gardening and agricultural uses.

Equipment: Very strong mulcher made of high yield sheet plate in order to support the most hard work. Sufficient protections to safeguard the operator's safety. Easy maintenance. Freewheel included in the gearbox. Timing belts SPBX. Hydraulic rear door. Very strong hammer holder shaft made of anti-wear steel plate with swinging/oscillating hammers 360°. Depth setting skids made of anti-wear steel. Third point category II. Transmission (optional). Rear pushing bar (optional). Hydraulic third point (optional). Reverse gearbox - so that the mulcher can be front-mounted (optional). Centrifugal starter clutch (optional). Rear door rake (optional)

TFV - BROYEUR FORESTIER À MARTEUX OSCILLANTS 360° POUR TRONCS JUSQU'À Ø30CM

Broyeur forestier pour le broyage des branches et troncs d'arbres jusqu'à 300 mm diamètre ainsi que pour le broyage de bois, jardinage et exploitation agricole.

Équipement: Très forte et robuste structure en acier à Haute Limite Elastique pour travailler a haut rendement. Protections suffisantes pour assurer la sécurité de l'opérateur. Facile d'entretien. Boîtier de renvoi d'angle à roue libre intégrée. Courroies de cardan SPBX dentées. Capot arrière à ouverture hydraulique. Arbre du rotor en acier anti-usure avec des marteaux oscillants 360°. Patins en acier anti-usure réglage en hauteur. Le troisième point est de catégorie II. Cardan (en option). Barre arrière pour tomber les arbres (en option). Troisième point hydraulique (en option). Boîtier réversible pour l'attelage frontal (en option). Embrayage centrifuge pour le démarrage (en option). Râteau sur la porte arrière (en option).



		Modelos		Model	Modèle	
		TFV 140	TFV 160	TFV 180	TFV 200	TFV 225
	Revol. min RPM TPM	1000	1000	1000	1000	1000
	Ancho trabajo Working width Largeur travail	1400	1600	1800	2000	2250
	Medidas exteriores Outer dimensions Mesures extérieures	A cm. 150 B cm. 173 C cm. 126	150 193 126	150 213 126	150 233 126	150 258 126
	Ø cm. máx. tronco Ø cm. máx. trunc Ø cm. max. trunc	30	30	30	30	30
	Martillos móviles G Swinging Hammers G Marteaux oscillants G	20	24	28	32	36
	Peso Weight Poids	1632	1733	1834	1930	2030
	Nº Correas Num. Belts Num. Courroies	6	6	6	6	6
	Potencia tractor (min-max) Tractor power (min-max) Puissance tracteur (min-max)	70-150	80-150	90-150	100-150	120-150
	Ø mm. Rotor con martillos Ø mm. Rotor with hammers Ø mm. Rotor avec marteaux	635	635	635	635	635
	Categ. engan. Attach. category Categ. attelage	2a	2a	2a	2a	2a
	Velocidad avance km/h Forward speed km/h Vitesse avancement km/h	0-6	0-6	0-6	0-6	0-6
	TFT medidas PTO measures Prise force mesures	1 3/8 z=6	1 3/8 z=6	1 3/8 z=6	1 3/8 z=6	1 3/8 z=6
	Protección delantera Front guard Protection frontal	Cadena doble Double chain Chaîne double				

* El Peso incluye la barra de tumbado | The weight includes the rear pushing bar | **Le poids contient la barre arrière**

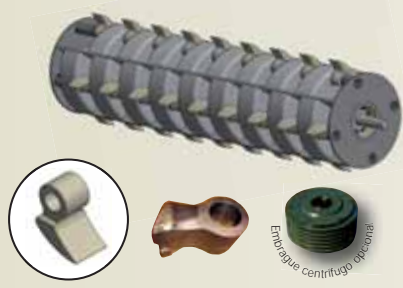

PRECIO | PRICE | PRIX

		Martillos de widia Widia hammers Marteaux en widia
TFV 140	14.845,00€	15.940,00€
TFV 160	15.616,00€	16.930,00€
TFV 180	16.080,00€	17.615,00€
TFV 200	17.237,00€	18.992,00€
TFV 225	17.730,00€	19.701,00€

Equipamiento de serie | Standard equipment | Équipement standard

- Rueda libre incluida en el grupo | Freewheel gearbox | **Boitier à roue libre**
- Chapa antidesgaste rotor | Hammer holder shaft made of anti-wear steel
Rotor en acier anti-usure
- Puerta trasera hidráulica | Hydraulic rear door | **Capot arrière à ouverture hydraulique**

Opciones | Options | Options

Transmision Transmission Cardan	392,00€
Barra de tumbado trasera Rear pushing bar Barre arrière pour tomber les arbres	700,00€
Barra de tumbado hidráulico Hydraulic rear pushing bar Hidráuliques barre arrière pour tomber les arbres	2.650,00€
Embrague centrífugo de puesta en marcha Starting centrifugal clutch Embrayage centrifuge pour le démarrage	3.975,00€
Tercer punto hidráulico Hydraulic third point Troisième point hydraulique	580,00€
Grupo reversible (para acoplamiento frontal tractor) Reverse gearbox Boitier reversible	480,00€
Rastrillo para barra de tumbado Rake for rear pushing bar Râteau pour barre arrière pour tomber des arbres	800,00€

TFVD • KASAR

TFVD - TRITURADORA FORESTAL DE MARTILLOS MÓVILES 360° DOBLE TRACCIÓN PARA TRONCOS DE HASTA Ø30CM

Trituradora forestal adecuada para arbustos y troncos de hasta 300 mm de diámetro así como para la trituración de madera, jardinería y agrícola.

Equipamiento: Construcción muy robusta para poder soportar los esfuerzos más intensos con chapa de alto límite elástico. Protecciones suficientes para salvaguardar la seguridad del operador. Fácil mantenimiento. Rueda libre incluida en el grupo multiplicador. Los modelos TFVD incorporan doble transmisión por correas. Correas de transmisión SPBX dentadas. Puerta trasera hidráulica. Rotor porta-martillos muy robusto de acero antidesgaste con martillos móviles/oscilantes 360°. Patines de acero anti-desgaste con una regulación de profundidad. Tercer punto de la categoría III. Transmisión (opcional). Barra de tumbado (opcional). Tercer punto hidráulico (opcional) Embrague centrífugo de puesta en marcha (opcional). Rastrillo puerta trasera (opcional)

TFVD - FORESTRY MULCHER WITH 360° SWINGING HAMMERS AND DOUBLE DRIVE FOR LOGS UP TO Ø30CM

Forestry mulcher best suited for trunks up to 300 mm diameter and for all types of wood, gardening and agricultural uses.

Equipment: Very strong mulcher made of high yield sheet plate in order to support the most hard work. Sufficient protections to safeguard the operator's safety. Easy maintenance. Freewheel included in the gearbox. TFVMD models feature double drive belt system. Timing belts SPBX. Hydraulic rear door. Very strong hammer holder shaft made of anti-wear steel plate with Swinging/Oscillating hammers 360°. Depth setting skids made of anti-wear steel. Third point category III. Transmission (optional). Rear pushing bar (optional). Hydraulic third point (optional). Centrifugal starter clutch (optional). Rear door rake (optional).

TFVD - BROYEUR FORESTIER À MARTEUX OSCILLANTS 360° AVEC DOUBLE ENTRAÎNEMENT POUR TRONCS JUSQU'À Ø30CM

Broyeur forestier pour le broyage des branches et troncs d'arbres jusqu'à 300 mm diamètre ainsi que pour le broyage de bois, jardinage et exploitation agricole.

Équipement: Très forte et robuste structure en acier à Haute Limite Elastique pour travailler a haut rendement. Protections suffisantes pour assurer la sécurité de l'opérateur. Facile d'entretien. Boîtier de renvoi d'angle à roue libre intégrée. Courroies de cardan SPBX dentées. Capot arrière à ouverture hydraulique. Arbre du rotor en acier anti-usure avec des marteaux oscillants 360°. Patins en acier anti-usure réglage en hauteur. Le troisième point est de catégorie III. Cardan (en option). Barre arrière pour tomber les arbres (en option). Troisième point hydraulique (en option). Embrayage centrifuge pour le démarrage (en option). Râteau sur la porte arrière (en option).



		Modelos	Model	Modèle
		TFVD 200	TFVD 225	TFVD 250
	Revol. min RPM TPM	1000	1000	1000
	Ancho trabajo Working width Largeur travail	2000	2250	2500
	Medidas exteriores Outer dimensions Mesures extérieures	A cm. 150 B cm. 236 C cm. 155	150 261 155	150 286 155
	Ø cm. máx. tronco Ø cm. máx. trunc Ø cm. max. tronc	30	30	30
	Martillos móviles G Swinging Hammers G Marteaux oscillants G	32	36	40
	Peso Weight Poids	2218	2392	2566
	Nº Correas Num. Belts Num. Courroies	12	12	12
	Potencia tractor (min-max) Tractor power (min-max) Puissance tracteur (min-max)	100-150	120-200	140-200
	Ø mm. Rotor con martillos Ø mm. Rotor with hammers Ø mm. Rotor avec marteaux	635	635	635
	Categ. engan. Attach. category Categ. attelage	2a	2a	2a
	Velocidad avance km/h Forward speed km/h Vitesse avancement km/h	0-6	0-6	0-6
	TFT medidas PTO measures Prise force mesures	1 3/4 z=6	1 3/4 z=6	1 3/4 z=6
	Protección delantera Front guard Protection frontal	Cadena doble Double chain Chaîne double		

* El Peso incluye la barra de tumbado | The weight includes the rear pushing bar | **Le poids contient la barre arrière**



PRECIO | PRICE | PRIX

		Martillos de widia Widia hammers Marteaux en widia
TFVD 200	20.826,00€	22.588,00€
TFVD 225	21.725,00€	23.697,00€
TFVD 250	22.637,00€	24.827,00€

Equipamiento de serie | Standard equipment | Équipement standard

- Rueda libre incluida en el grupo | Freewheel gearbox | **Boîtier à roue libre**
- Chapa antidesgaste rotor | Hammer holder shaft made of anti-wear steel
Rotor en acier anti-usure
- Puerta trasera hidráulica | Hydraulic rear door | **Capot arrière à ouverture hydraulique**

Opciones | Options | Options

Transmision Transmission Cardan	392,00€
Barra de tumbado trasera Rear pushing bar Barre arrière pour tomber les arbres	850,00€
Embrague centrífugo de puesta en marcha Starting centrifugal clutch Embrayage centrifuge pour le démarrage	7.950,00€
Tercer punto hidráulico Hydraulic third point Troisième point hydraulique	582,00€
Rastrillo para barra de tumbado Rake for rear pushing bar Râteau pour barrer arrière pour tomber les arbres	800,00€
Barra de tumbado hidráulico Hydraulic rear pushing bar Hidrauliques barre arrière pour tomber les arbres	2.650,00€

TFVMF • JUBBA

TFVMF - TRITURADORA FORESTAL DE MARTILLOS FIJOS CON PUNTA DE WIDIA PARA TRONCOS DE HASTA Ø30CM

Trituradora forestal adecuada para arbustos y troncos de hasta 300 mm de diámetro así como para la trituración de madera, jardinería y agrícola.

Equipamiento: Construcción muy robusta para poder soportar los esfuerzos más intensos con chapa de alto límite elástico. Protecciones suficientes para salvaguardar la seguridad del operador. Fácil mantenimiento. Rueda libre incluida en el grupo multiplicador. Correas de transmisión SPBX dentadas. Puerta trasera hidráulica. Martillos fijos de punta de widia y tungsteno. Patines de acero anti-desgaste con una regulación de profundidad. Tercer punto de la categoría III. Transmisión (opcional). Barra de tumbado (opcional). Tercer punto hidráulico. (opcional) Grupo reversible para el acoplamiento frontal del tractor (opcional). Patines para trabajo de profundidad (opcional) Embrague centrífugo de puesta en marcha (opcional). Rastrillo puerta trasera (opcional)

TFVMF - FORESTRY MULCHER WITH FIXED WIDIA HAMMERS FOR LOGS UP TO Ø30CM

Forestry mulcher best suited for trunks up to 300 mm diameter and for all types of wood, gardening and agricultural uses.

Equipment: Very strong mulcher made of high yield sheet plate in order to support the most hard work. Sufficient protections to safeguard the operator's safety. Easy maintenance. Freewheel included in the gearbox. Timing belts SPBX. Hydraulic rear door Fixed hammers with widia/Tungsten tips. Depth setting skids made of anti-wear steel. Third point category III. Transmission (optional). Rear pushing bar (optional). Hydraulic third point (optional) Reverse gearbox - so that the mulcher can be front-mounted (optional). Skids for depth work. (optinal) Centrifugal starter clutch (optional). Rear door rake (optional).

TFVMF - BROYEUR FORESTIER À MARTEUX FIXES EN WIDIA POUR TRONCS JUSQU'À Ø30CM

Broyeur forestier pour le broyage des branches et troncs d'arbres jusqu'à 300 mm diamètre ainsi que pour le broyage de bois, jardinage et exploitation agricole.

Équipement: Très forte et robuste structure en acier à Haute Limite Élastique pour travailler a haut rendement. Protections suffisantes pour assurer la sécurité de l'opérateur. Facile d'entretien. Boîtier de renvoi d'angle à roue libre intégrée. Courroies de cardan SPBX dentées. Capot arrière à ouverture hydraulique. Marteaux fixes avec pointe en Widia/Tungsten. Patins en acier anti-usure réglage en hauteur. Troisième point hydraulique (en option). Boîtier réversible pour l'attelage frontal (en option). Patins pour travail en profondeur (en option). Embrayage centrifuge pour le démarrage (en option). Râteau sur la porte arrière (en option).



		Modelos		Model	Modèle	
		TFVMF 140	TFVMF 160	TFVMF 180	TFVMF 200	TFVMF 225
	Revol. min RPM TPM	1000	1000	1000	1000	1000
	Ancho trabajo Working width Largeur travail	1400	1600	1800	2000	2250
	Medidas exteriores Outer dimensions Mesures extérieures	A cm. 150 B cm. 173 C cm. 126	150 193 126	150 213 126	150 233 126	150 258 126
	Profundidad cm Depth cm Profondeur cm	9	9	9	9	9
	Ø cm. máx. tronco Ø cm. máx. trunc Ø cm. max. tronc	30	30	30	30	30
	Martillos fijos Vidia Fixed Widia Hammers Marteaux fixes Vidia	20+2	24+2	28+2	32+2	34+2
	Peso Weight Poids	1445	1522	1600	1678	1758
	Nº Correas Num. Belts Num. Courroies	6	6	6	6	6
	Potencia tractor (min-max) Tractor power (min-max) Puissance tracteur (min-max)	70-150	80-150	90-150	100-150	120-150
	Ø mm. Rotor con martillos Ø mm. Rotor with hammers Ø mm. Rotor avec marteaux	585	585	585	585	585
	Categ. engan. Attach. category Categ. attelage	2a	2a	2a	2a	2a
	Velocidad avance km/h Forward speed km/h Vitesse avancement km/h	0-6	0-6	0-6	0-6	0-6
	TFT medidas PTO measures Prise force mesures	1 3/8 z=6	1 3/8 z=6	1 3/8 z=6	1 3/8 z=6	1 3/8 z=6
	Protección delantera Front guard Protection frontal	Cadena doble Double chain Chaîne double				

* El Peso incluye la barra de tumbado | The weight includes the rear pushing bar | **Le poids contient la barre arrière**



PRECIO | PRICE | PRIX

TFVMF 140	18.820,00€
TFVMF 160	19.495,00€
TFVMF 180	20.162,00€
TFVMF 200	21.116,00€
TFVMF 225	21.804,00€

Equipamiento de serie | Standard equipment | Équipement standard

- Rueda libre incluida en el grupo | Freewheel gearbox | **Boîtier à roue libre**
- Puerta trasera hidráulica | Hydraulic rear door | **Capot arrière à ouverture hydraulique**

Opciones | Options | Options

Transmisión con limitador Transmission with limiter Avec limiteur Bondioli Pavesi	1.145,00€
Transmisión Transmission Transmission	392,00€
Barra de tumbado trasera Rear pushing bar Barre arrière pour tomber les arbres	850,00€
Embrague centrífugo de puesta en marcha Starting centrifugal clutch Embrague centrifuge pour le démarrage	3.975,00€
Tercer punto hidráulico Hydraulic third point Troisième point hydraulique	580,00€
Grupo reversible (para acoplamiento frontal tractor) Reverse gearbox Boîtier reversible	480,00€
Patines para trabajo de profundidad Skids for depth work Patins pour travail en profondeur	350,00€
Rastrillo para barra de tumbado Rake for rear pushing bar Râteau pour barrer arrière pour tomber les arbres	800,00€
Barra de tumbado hidráulico Hydraulic rear pushing bar Hidráuliques barre arrière pour tomber les arbres	2.650,00€

TFVMFD • ELSA

TFVMFD - TRITURADORA FORESTAL DE MARTILLOS FIJOS CON PUNTA DE WIDIA DOBLE TRACCIÓN PARA TRONCOS DE HASTA Ø35CM

Trituradora forestal adecuada para arbustos y troncos de hasta 350 mm de diámetro así como para la trituración de madera, jardinería y agrícola.

Equipamiento: Construcción muy robusta para poder soportar los esfuerzos más intensos con chapa de alto límite elástico. Protecciones suficientes para salvaguardar la seguridad del operador. Fácil mantenimiento. Rueda libre incluida en el grupo multiplicador. Los modelos TFVMFD incorporan doble transmisión por correas. Correas de transmisión SPBX dentadas. Puerta trasera hidráulica. Martillos fijos de punta de widia y tungsteno. Patines de acero anti-desgaste con una regulación de profundidad. Tercer punto de la categoría III. Transmisión (opcional). Barra de tumbado (opcional). Tercer punto hidráulico (opcional). Embrague centrífugo de puesta en marcha (opcional). Patines para trabajo de profundidad (opcional). Rastrillo puerta trasera (opcional).



TFVMFD - FORESTRY MULCHER WITH FIXED WIDIA HAMMERS AND DOUBLE DRIVE FOR LOGS UP TO Ø35CM

Forestry mulcher best suited for trunks up to 350 mm diameter and for all types of wood, gardening and agricultural uses.

Equipment: Very strong mulcher made of high yield sheet plate in order to support the most hard work. Sufficient protections to safeguard the operator's safety. Easy maintenance. Freewheel included in the gearbox. TFVMFD models feature double drive belt system. Timing belts SPBX. Hydraulic rear door. Fixed hammers with widia/Tungsten tips. Depth setting skids made of anti-wear steel. Third point category III. Transmission (optional). Rear pushing bar (optional). Hydraulic third point (optional). Centrifugal starter clutch (optional). Skids for depth work. (optional) Rear door rake (optional)

TFVMFD - BROYEUR FORESTIER À MARTEUX FIXES EN WIDIA AVEC DOUBLE ENTRAÎNEMENT POUR TRONCS JUSQU'À Ø35CM

Broyeur forestier pour le broyage des branches et troncs d'arbres jusqu'à 350 mm diamètre ainsi que pour le broyage de bois, jardinage et exploitation agricole.

Équipement: Très forte et robuste structure en acier à Haute Limite Elastique pour travailler à haut rendement. Protections suffisantes pour assurer la sécurité de l'opérateur. Facile d'entretien. Boîtier de renvoi d'angle à roue libre intégrée. Les modèles TFVMFD disposent de double entraînement par courroie. Courroies de cardan SPBX dentées. Capot arrière à ouverture hydraulique. Marteaux fixes avec pointe en Widia/Tungsten. Patins en acier anti-usure réglage en hauteur. Le troisième point est de catégorie III. Cardan (en option). Barre arrière pour tomber les arbres (en option). Troisième point hydraulique (en option). Embrayage centrifuge pour le démarrage (en option). Patins pour travail en profondeur (en option). Râteau sur la porte arrière (en option).



		Modelos	Model	Modèle
		TFVMFD 200	TFVMFD 225	TFVMFD 250
	Revol. min RPM TPM	1000	1000	1000
	Ancho trabajo Working width Largeur travail	2000	2250	2500
	Medidas exteriores Outer dimensions Mesures extérieures	A cm. 150 B cm. 236 C cm. 155	150 261 155	150 286 155
	Profundidad cm Depth cm Profondeur cm	9	9	9
	Ø cm. máx. tronco Ø cm. máx. trunc Ø cm. max. tronc	35	35	35
	Martillos fijos Vidia Fixed Widia Hammers Marteaux fixes Widia	32+2	34+2	38+2
	Peso Weight Poids	2072	2176	2282
	Nº Correas Num. Belts Num. Courroies	12	12	12
	Potencia tractor (min-max) Tractor power (min-max) Puissance tracteur (min-max)	100-150	120-150	140-150
	Ø mm. Rotor con martillos Ø mm. Rotor with hammers Ø mm. Rotor avec marteaux	585	585	585
	Categ. engan. Attach. category Categ. attelage	2a	2a	2a
	Velocidad avance km/h Forward speed km/h Vitesse avancement km/h	0-6	0-6	0-6
	TFT medidas PTO measures Prise force mesures	1 3/4 z=6	1 3/4 z=6	1 3/4 z=6
	Protección delantera Front guard Protection frontal	Cadena doble Double chain Chaîne double		

* El Peso incluye la barra de tumbado | The weight includes the rear pushing bar | **Le poids contient la barre arrière**

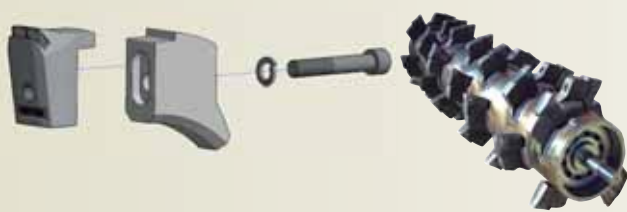

PRECIO | PRICE | PRIX

TFVMFD 200	23.848,00€
TFVMFD 225	24.564,00€
TFVMFD 250	25.665,00€

Equipamiento de serie | Standard equipment | Équipement standard

- Rueda libre incluida en el grupo | Freewheel gearbox | **Boitier à roue libre**
- Puerta trasera hidráulica | Hydraulic rear door | **Capot arrière à ouverture hydraulique**

Opciones | Options | Options

Transmisión con limitador Transmission with limiter Avec limiteur Bondioli Pavesi	1.212,00€
Barra de tumbado trasera Rear pushing bar Barre arrière pour tomber les arbres	850,00€
Embrague centrífugo de puesta en marcha Starting centrifugal clutch Embrayage centrifuge pour le démarrage	7.950,00€
Tercer punto hidráulico Hydraulic third point Troisième point hydraulique	580,00€
Patines para trabajo de profundidad Skids for depth work Patins pour travail en profondeur	350,00€
Barra de tumbado hidráulico Hydraulic rear pushing bar Hidrauliques barre arrière pour tomber les arbres	2.650,00€

TFMF • MADEIRA

TFMF - MADEIRA - TRITURADORA FORESTAL CON MARTILLOS FIJOS DE VIDIA PARA TRACTORES DE 200 A 400CV
 Trituradora forestal adecuada para arbustos y troncos de hasta 500 mm de diámetro. Y adecuado para la trituración de madera. Equipada con rueda libre incluida en el grupo multiplicador y puerta trasera hidráulica incluido.

Opciones

- Transmisión con limitador
- Enganche tripuntal regulable
- Barra de tumbado trasera reforzada
- Barra de tumbado trasera reforzada hidráulicamente
- Patines para trabajo de profundidad
- Rastrillo de puerta trasera

TFMF - MADEIRA - FORESTRY MULCHER WITH RIGID FIXED VIDIA HAMMERS FOR TRACTORS FROM 200 TO 400HP

Forestry mulcher best suited for trunks up to 500 mm diameter. Suitable for all types of wood uses. Equipped with freewheel included in the gearbox and hydraulic rear door.

Options

- Transmission with limiter
- Adjustable 3-point hitch
- Strengthened rear pushing bar
- Skids for depth work
- Rear door rake

TFMF - MADEIRA - BROYEUR FORESTIER À MARTEAUX VIDIA RIGIDES POUR TRACTEURS DE 200 À 400 CV

Broyeur forestier idéal pour les troncs jusqu'à 500 mm de diamètre. Convient à tous les types de bois les usages. Équipé deroue libre incluse dans la boîte de vitesses.et porte arrière hydraulique

Les options

- Transmission avec limiteur
- Attelage 3 points réglable
- Barre de poussée arrière renforcée
- Patins pour le travail en profondeur
- Râteau de porte arrière

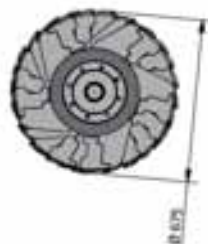

		Modelos	Model	Modèle
		TFMF 200	TFMF 225	TFMF 250
	Revol. min RPM TPM	1000	1000	1000
	Ancho trabajo Working width Largeur travail	2000	2250	2500
	Medidas exteriores Outer dimensions Mesures extérieures	A cm. 234 B cm. 246 C cm. 170	234 271 170	234 296 170
	Profundidad cm Depth cm Profondeur cm	15	15	15
	Ø cm. máx. tronco Ø cm. máx. trunc Ø cm. max. tronc	50	50	50
	Martillos fijos Vidia Fixed Widia Hammers Marteaux fixes Widia	52+2	60+2	68+2
	Peso Weight Poids	3732	4032	4332
	Nº Correas Num. Belts Num. Courroies	10	10	10
	Potencia tractor (min-max) Tractor power (min-max) Puissance tracteur (min-max)	200-400	200-400	200-400
	Ø mm. Rotor con martillos Ø mm. Rotor with hammers Ø mm. Rotor avec marteaux	675	675	675
	Categ. engan. Attach. category Categ. attelage	2a	2a	2a
	Velocidad avance km/h Forward speed km/h Vitesse avancement km/h	0-4	0-4	0-4
	TFT medidas PTO measures Prise force mesures	1 3/4 z=20	1 3/4 z=20	1 3/4 z=20
	Protección delantera Front guard Protection frontal	Cadena doble Double chain Chaîne double		

* El Peso incluye la barra de tumbado | The weight includes the rear pushing bar | **Le poids contient la barre arrière**

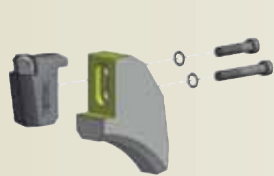

PRECIO | PRICE | PRIX

TFMF 200	47.200,00€
TFMF 225	49.100,00€
TFMF 250	51.080,00€

Equipamiento de serie | Standard equipment | Équipement standard

- Rueda libre incluida en el grupo | Freewheel gearbox | **Boîtier à roue libre**
- Puerta trasera hidráulica | Hydraulic rear door | **Capot arrière à ouverture hydraulique**

Opciones | Options | Options

Transmisión con limitador Transmission with limiter Avec limiteur Bondioli Pavesi	1.910,00€
Enganche tripuntal regulable Adjustable 3-point hitch Attelage 3-points réglable	1.290,00€
Barra de tumbado trasera reforzada Strengthened rear pushing bar Barre arrière renforcé pour tomber les arbres	1.750,00€
Barra de tumbado trasero reforzado hidráulico Hydraulic strengthened rear pushing bar Barre arrière renforcé pour tomber les arbres	3.350,00€
Patines para trabajo de profundidad Skids for depth work Patins pour travail en profondeur	596,00€
Rastrillo para barra de tumbado hidráulico Rake for hydraulic rear pushing bar Râteau hydrauliques pour barre arrière pour tomber les arbres	550,00€
Tercer punto hidráulico Third hydraulic point Troisième point hydraulique	940,00€

VENTURA 80/42 • GANGES

VENTURA 80/42 - DESTOCONADORA

Existen pocas alternativas para el triturado selectivo o la eliminación de tocones. Los tocones pueden suponer grandes obstáculos en muchos lugares. Con nuestra fresadora se puede destruir un tocón hasta una profundidad de 40 cm. El material fresado normalmente se queda en el hueco fresado. Accionamiento bilateral del rotor de fresado a través de la caja de transmisión montado de forma pivotante. La transmisión se ajusta automáticamente a los movimientos de la pluma y del brazo principal. La flexión de la articulación del eje de transmisión se reduce al mínimo. Los componentes del tren se protegen y se prolonga la vida de los elementos principales de accionamiento.





VENTURA 80/42 - STUMP CUTTER

There are only a few options for the selective reduction or removal of root stocks. Remaining root stocks can be a major obstacle in many places. A root stock can be milled off up to a depth of 40 cm in the soil using a stump grinder. The milled material is usually left in the milled hole. The double-sided tiller rotor driver is done via a swiveling transfer case. The gearbox automatically adjusts to the movements of the side arm and the main arm - the bending of the drive shaft joint is minimized. The entire drive train is protected, which increases the life of the main driving elements.

VENTURA 80/42 - ROGNEUSE DE SOUCHES

Les alternatives au broyage ou à l'enlèvement sélectif des souches sont peu nombreuses. Dans de nombreux endroits, les souches verticales peuvent constituer un obstacle majeur. Notre fraise de souches permet de fraiser une souche dans le sol jusqu'à 40 cm de profondeur. La matière fraisée reste généralement dans le trou fraisé. L'entraînement bilatéral du rotor de fraisage s'effectue par un boîtier de transfert monté de façon à pouvoir pivoter. La boîte de vitesses s'adapte automatiquement aux mouvements de la flèche et du bras principal; le pliage de l'arbre de cardan est minimisé. L'ensemble de la chaîne cinématique est préservé et la durée de vie des éléments de l'entraînement principaux est augmentée.



		Modelos Model Modèle
		80/42
	Ancho trabajo Working width Largeur travail	800
	Profundidad mm Depth cm Profondeur mm	300
	Martillos fijos Vidia Fixed Vidia Hammers Marteaux fixes Vidia	32+2
	Peso Weight Poids	2200
	Potencia tractor (min-max) Tractor power (min-max) Puissance tracteur (min-max)	150-300
	RPM RPM RPM	1.000
	Ø mm. Rotor con martillos Ø mm. Rotor with hammers Ø mm. Rotor avec marteau	1.230 mm
	Medidas Measures Dimensions	1.30 x 1.68 x 1.55 h

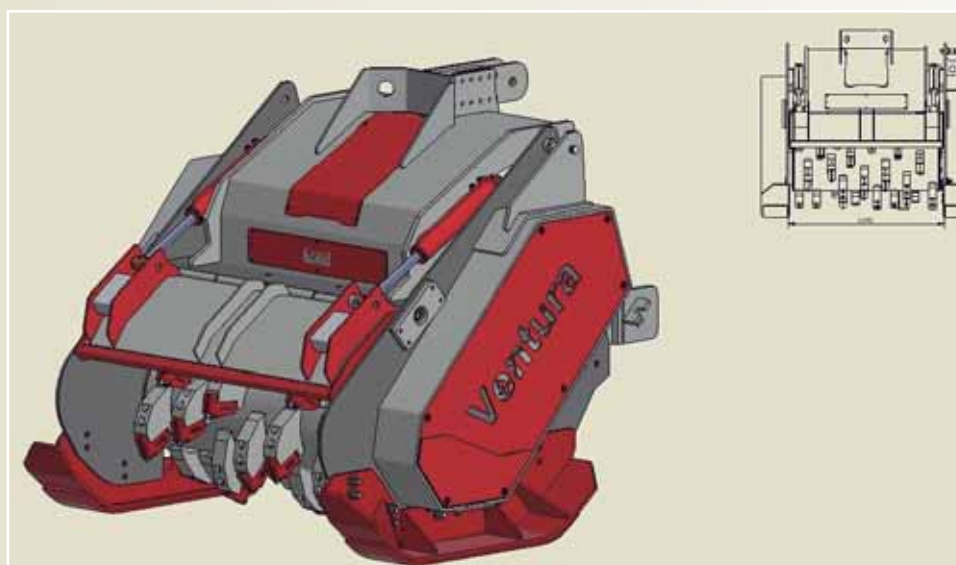

Equipamiento de serie | Standard equipment | **Équipement standard**

- Toma de fuerza | PTO / Prise de force
- Profundidad de trabajo | Working depth | **Profondeur du travail: 300 mm**

PRECIO | PRICE | **PRIX**

80/42	57.385,00€
-------	------------





Trituradoras de piedras
Stone crusher
Broyeur de pierres

TPV • TÍBER

TPV - TÍBER - Trituradora de piedra y madera y fresadora de suelos. Trituradora de piedra y madera y fresadora de suelos, caminos, pistas forestales. Recicla la piedra convirtiéndola en arena para la preparación del terreno.

Equipamiento

- Toda formada con chapa Hardox antidesgaste intercambiable todo el chasis.
- Construcción robusta para poder soportar los esfuerzos más intensos con la chapa de alto límite elástico.
- Revestimiento en todo el bastidor y puerta trasera de chapa antidesgaste desmontable de fácil cambio
- Tritura piedra de 1 a 14 cm
- 9 cm de profundidad de fresado.
- Martillos de vidia de tungsteno con tratamiento especial.
- Protecciones adicionales con doble cadena para salvaguardar la seguridad del operador.
- Fácil mantenimiento.
- Contra la cuchilla móvil regulable según desgaste.
- Rueda libre incluida en el grupo multiplicador.
- Los modelos TPVD incorporan doble transmisión por correas
- Correas de transmisión SPBX dentadas.
- Puerta trasera hidráulica.
- Patines de acero anti-desgaste con una regulación de profundidad
- Tercer punto de la categoría III.
- Transmisión (serie).
- Barra de tumbado (opcional).
- Tercer punto hidráulico (opcional).
- Embrague centrífugo de puesta en marcha (Opcional).
- Aplanador trasero (opcional).
- Rodillo trasero de control (opcional).

TPV - TÍBER - Stone and forestry mulcher and soil stabilizer. Suitable for Crushing stones and wood, soil milling, road maintenance and stone recycling. It converts the stones into dust in order to fulfil site preparation purposes.

Equipment

- All formed with replaceable Hardox sheet wear the entire chassis.
- Robust machine made in high yield steel chassis in order to withstand the most intense efforts
- Detachable anti-wear plate frame & back cover for easy changeover.
- Can crush stones from 1 to 14 cm.
- Milling depth 9 cm.
- Widia Hammers with tungsten tip, specially treated.
- Sufficient protections to safeguard the operator's safety.
- Easy maintenance.
- Adjustable counter knife against wear.
- Freewheel in the gearbox
- Belt Driven
- Timing Belts SPBX
- Hydraulic rear door.
- Depth setting skids made of anti-wear Steel (standard).
- Third point category III.
- Transmission (standard).
- Push Bar (optional).
- Third hydraulic point (optional).
- Centrifugal starter clutch (optional).
- Rear grader blade (optional)
- Rear roller control (optional).



TPV - TÍBER - Broyeur de pierres et forêts et stabilisateur de sol. Convient pour le concassage de pierres et de bois, le fraisage du sol, l'entretien des routes et le recyclage de la pierre. Il convertit les pierres en poussière afin de permettre la préparation du site.

Équipement

- Tous formés avec la feuille remplaçable de Hardox portent le châssis entier.
- Machine robuste fabriquée dans un châssis en acier à haut rendement afin de résister aux efforts les plus intenses
- Cadre de plaque anti-usure et couvercle arrière amovibles pour faciliter le changement.
- Peut écraser des pierres de 1 à 14 cm.
- Profondeur de fraisage 9 cm.
- Widia Marteaux à pointe en tungstène spécialement traités.
- Protections suffisantes pour la sécurité de l'opérateur.
- Entretien facile.
- Contre couteau réglable contre l'usure.
- Roue libre dans la boîte de vitesses
- Entraînement par courroie
- Courroies SPBX
- Porte arrière hydraulique.
- Patins à réglage en profondeur en acier anti-usure (standard).
- Troisième catégorie de point III.
- Transmission (standard).
- Barre de poussée (facultatif).
- Troisième point hydraulique (facultatif).
- Embrayage de démarrage centrifuge (en option).
- Lame de niveleuse arrière (en option)
- Commande du rouleau arrière (en option).



		Modelos	Model	Modèle
		TPV 140	TPV 160	TPV 180
	Revol. min RPM TPM	1000	1000	1000
	Ancho trabajo Working width Largeur travail	1400	1600	1800
	Medidas exteriores Outer dimensions Mesures extérieures	A cm. 150 B cm. 173 C cm. 126	150 193 126	150 213 126
	Profundidad cm Depth cm Profondeur cm	9	9	9
	Ø cm. máx. piedra Ø cm. máx. stone Ø cm. max. pierre	20	20	20
	Martillos fijos Vidia Fixed Vidia Hammers Marteaux fixes Vidia	22	26	30
	Peso Weight Poids	1734	1826	1920
	Nº Correas Num. Belts Num. Courroies	6	6	6
	Potencia tractor (min-max) Tractor power (min-max) Puissance tracteur (min-max)	70-150	80-150	90-150
	Ø mm. Rotor con martillos Ø mm. Rotor with hammers Ø mm. Rotor avec marteaux	585	585	585
	Categ. engan. Attach. category Categ. attelage	2a	2a	2a
	Velocidad avance km/h Forward speed km/h Vitesse avancement km/h	0-6	0-6	0-6
	TFT medidas PTO measures Prise force mesures	1 3/8 z=6	1 3/8 z=6	1 3/8 z=6
	Protección delantera Front guard Protection frontal	Cadena doble Double chain Chaîne double		



PRECIO | PRICE | PRIX

TPV 140	25.585,00€
TPV 160	26.260,00€
TPV 180	26.940,00€

Opciones | Options | Options

Transmisión Transmission Cardan	392,00€
Transmisión con limitador Transmission with limiter Avec limiteur Bondioli Pavesi	1.145,00€
Barra de tumbado mecánica Mechanical rear pushing bar Mécanique barre arrière pour tomber les arbres	850,00€
Barra de tumbado hidráulica Hydraulic rear pushing bar Hidráulique barre arrière pour tomber les arbres	2.650,00€
Rastrillo para barra de tumbado hidráulico Rake for hydraulic rear pushing bar Râteau hydrauliques pour barre arrière pour tomber les arbres	800,00€
Tercer punto hidráulico Third hydraulic point Troisième point hydraulique	940,00€

TPVD • ARKANSAS

TPVD – Trituradora de piedra y fresadora de suelos, caminos, pistas forestales recicla la piedra. Convirtiendo en arena para la preparación del terreno.

Equipamiento

- Toda formada con chapa Hardox antidesgaste recambiable todo el chasis.
- Construcción muy robusta para poder soportar los esfuerzos más intensos con chapa de alto límite elástico.
- Revestimiento en todo el bastidor y puerta trasera de chapa antidesgaste desmontable de fácil cambio.
- Tritura piedra de 1 a 20cm.
- 13cm de profundidad de fresado.
- Martillos de widia de tungsteno con tratamiento especial.
- Protecciones suficientes con doble cadena para salvaguardar la seguridad del operador.
- Fácil mantenimiento.
- Rueda libre incluida en el grupo multiplicador.
- Los modelos TPVD incorporan doble transmisión por correas.
- Correas de transmisión SPBX dentadas.
- Puerta trasera hidráulica.
- Patines de acero anti-desgaste con una regulación de profundidad.
- Tercer punto de la categoría III.
- Transmisión (de serie).
- Patines para trabajo de profundidad (de serie).
- Barra de tumbado (opcional).
- Tercer punto hidráulico (opcional).
- Embrague centrífugo de puesta en marcha (opcional).
- Aplanador de trasero (opcional).
- Rastrillo puerta trasera (opcional).

TPVD – Stone Crusher & Soil Stabilizer Suitable for Crushing stones, soil milling, road maintenance and stone recycling.

It converts the stones into dust in order to fulfil site preparation purposes.

Equipment

- All formed with replaceable Hardox sheet wear the entire chassis.
- Robust machine made in high yield steel chassis in order to withstand the most intense efforts
- Detachable anti-wear plate frame & back cover for easy changeover.
- Can crush stones from 1 to 20 cm.
- Milling depth 13 cm.
- Widia Hammers with tungsten tip, specially treated.
- Sufficient protections to safeguard the operator's safety.
- Easy maintenance.
- Freewheel in the gearbox
- Belt Driven – Double Drive.
- Timing Belts SPBX
- Hydraulic rear door.
- Skids made in anti-wear steel with depth settings.
- Third point category III.
- Transmission (standard).
- Depth setting skids (standard).
- Push Bar (optional).
- Third hydraulic point (optional).
- Centrifugal starter clutch (optional).
- Rear grader blade (optional)
- Rear door rake (optional).

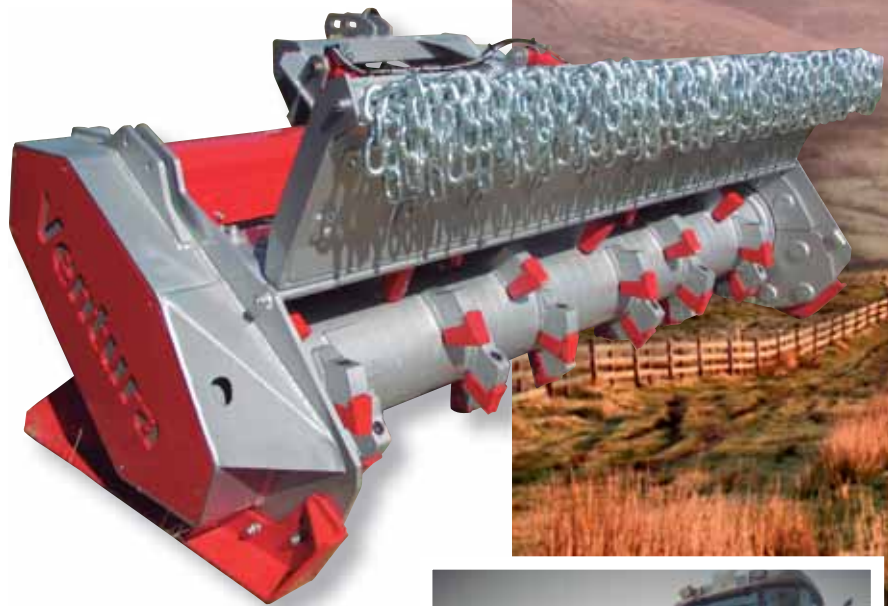

TPVD • Broyeur de pierres & Stabilisateur de sol

Cette model est conçue pour le concassage des pierres, le fraisage du sol, l'entretien des routes et le recyclage des pierres. La machine sert à détruire la pierre i la transformer en petites particules.

Équipement

- Tous formés avec la feuille remplaçable de Hardox portent le châssis entier.
- Machine robuste fabriquée avec un châssis en acier à haut rendement pour résister aux efforts les plus intenses.
- Cadre et capot arrière en acier anti-usure et amovibles pour une commutation facile.
- Peut écraser des pierres de 1 à 20 cm.
- Profondeur de fraisage de 13 cm.
- Marteaux en Widia avec pointe de tungstène. Spécialément traités.
- Des protections suffisantes pour protéger la sécurité de l'opérateur.
- Entretien facile.
- Roue libre dans la boîte de vitesses
- Entraînement par courroie
- Courroies de distribution SPBX
- Porte arrière hydraulique.
- Patins en acier anti-usure avec réglages de profondeur.
- Troisième catégorie de points III.
- Cardan (standard).
- Patins de réglage de profondeur (standard).
- Barre de poussée (en option).
- Troisième point hydraulique (en option).
- Embrayage centrifuge (optionnel).
- Lame niveleuse arrière (en option)
- Râteau dans la porte arrière (en option).



		Modelos	Model	Modèle
		TPVD 200	TPVD 225	TPVD 250
	Revol. min RPM TPM	1000	1000	1000
	Ancho trabajo Working width Largeur travail	2000	2250	2500
	Medidas exteriores Outer dimensions Mesures extérieures	A cm. 110 B cm. 233 C cm. 126	110 258 126	110 283 126
	Profundidad cm Depth cm Profondeur cm	13	13	13
	Ø cm. máx. piedra Ø cm. máx. stone Ø cm. max. pierre	20	20	20
	Martillos fijos Vidia Fixed Vidia Hammers Marteaux fixes Vidia	32+2	34+2	38+2
	Peso Weight Poids	2610	2724	2840
	Nº Correas Num. Belts Num. Courroies	12	12	12
	Potencia tractor (min-max) Tractor power (min-max) Puissance tracteur (min-max)	100-230	120-230	130-230
	Ø mm. Rotor con martillos Ø mm. Rotor with hammers Ø mm. Rotor avec marteaux	585	585	585
	Categ. engan. Attach. category Categ. attelage	2a	2a	2a
	Velocidad avance km/h Forward speed km/h Vitesse avancement km/h	0.2-2.5	0.2-2.5	0.2-2.5
	TFT medidas PTO measures Prise force mesures	1 3/4 z=6	1 3/4 z=6	1 3/4 z=6
	Protección delantera Front guard Protection frontal	Cadena doble Double chain Chaîne double		



PRECIO | PRICE | PRIX

TPVD 200	35.380,00€
TPVD 225	36.900,00€
TPVD 250	38.420,00€

Opciones | Options | Options

Transmisión Transmission Cardan	392,00€
Transmisión con limitador Transmission with limiter Avec limiteur Bondioli Pavesi	1.175,00€
Niveladora trasera Rear grader Lame niveuleuse arrière	7.200,00€
Barra de tumbado mecánica Mechanical rear pushing bar Mécanique barre arrière pour tomber les arbres	750,00€
Barra de tumbado hidráulica Hydraulic rear pushing bar Hidráulique barre arrière pour tomber les arbres	2.650,00€
Rastrillo para barra de tumbado hidráulico Rake for hydraulic rear pushing bar Râteau hydrauliques pour barre arrière pour tomber les arbres	800,00€
Tercer punto hidráulico Third hydraulic point Troisième point hydraulique	940,00€

TFMFP • TER



TRITURADORA FORESTAL DE PIEDRAS Y FRESADORA.

Esta máquina puede trabajar a 2 velocidades (1000 Rev./min como trituradora forestal y a 540 Rev./min como trituradora de piedra) y tritura hasta 40 cm diámetro de leña y 30 cm de piedra o roca.

Equipamiento de serie: Sistema de regulación automático del paralelismo tipo Z entre la caja de cambios y la cardán; contra cuchilla intercambiable y regulable en HARDOX; transmisión lateral a ambos lados de los engranajes; cardan con limitador; puerta trasera hidráulica; grupo de engranajes con rueda libre, placas de anti desgaste, enganche tres puntos al tractor, regulable y protección en los cilindros.

FORESTRY MULCHER – STONE CRUSHER – SOIL STABILIZER

This machine can work at 2 speeds (1000 Rev./min as a forest mulcher and at 540 Rev./min as a stone mulcher) and crush up to 40 cm diameter of firewood and 30 cm of stone or rock.

Standard equipment: Automatic regulation system of the Z-type parallelism between the gearbox and the PTO; interchangeable counterknife and adjustable blade in HARDOX; lateral transmission on both sides of the gears; transmission with limiter; hydraulic rear door; gear group with freewheel, anti-wear plates, three points linkage to the tractor and adjustable and protection on the cylinders.

BROYEUR FORESTIER – BROYEUR DE PIERRES – STABILISATEUR DE SOL

Cette machine peut travailler à 2 vitesses (1000 tr / min en tant que concasseur forestier et à 540 tr / min en tant que concasseur de pierres) et concasser jusqu'à 40 cm de diamètre de bois de chauffage et 30 cm de pierre ou de roche.

Equipement standard: Système de régulation automatique du parallélisme de type Z entre la boîte de vitesses et le cardan; contre lame interchangeable et réglable en HARDOX; transmission latérale des deux côtés des engrenages; carte avec limiteur; porte arrière hydraulique; groupe d'engrenages avec roue libre, plaques anti-usure, crochet trois points au tracteur, réglable et protection dans les cylindres.

		Modelos	Model	Modèle	
		TFMFP 180	TFMFP 200	TFMFP 225	TFMFP 250
	Revol. min RPM TPM	540 - 1000	540 - 1000	540 - 1000	540 - 1000
	Ancho trabajo Working width Largeur travail	1800	2000	2250	2500
	Medidas exteriores Outer dimensions Mesures extérieures	A cm. 150 B cm. 228 C cm. 240	150 248 240	150 273 240	150 298 240
	Profundidad cm Depth cm Profondeur cm	30	30	30	30
	Ø cm. máx. tronco Ø cm. máx. trunc Ø cm. max. tronc	40	40	40	40
	Ø cm. máx. piedra Ø cm. máx. stone Ø cm. max. pierre	30	30	30	30
	Martillos fijos Vidia Fixed Widia Hammers Marteaux fixes Widia	48+2	52+2	60+2	68+2
	Peso Weight Poids	3145	3680	3980	4280
	Nº Correas Num. Belts Num. Courroies	Doble caja de engranajes Double gearbox Double boîte de vitesses			
	Potencia tractor (min-max) Tractor power (min-max) Puissance tracteur (min-max)	180-260	180-260	180-260	180-260
	Ø mm. Rotor con martillos Ø mm. Rotor with hammers Ø mm. Rotor avec marteaux	675	675	675	675
	Categ. engan. Attach. category Categ. attelage	2a	2a	2a	2a
	Velocidad avance km/h Forward speed km/h Vitesse avancement km/h	0.2-2	0.2-2	0.2-2	0.2-2
	TFT medidas PTO measures Prise force mesures	1 3/4 z=20	1 3/4 z=20	1 3/4 z=20	1 3/4 z=20
	Protección delantera Front guard Protection frontal	Cadena doble Double chain Chaîne double			

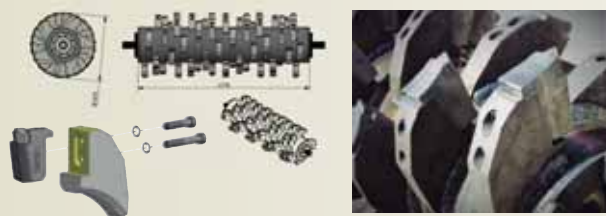

PRECIO | PRICE | PRIX

TFMFP 180	54.850,00€
TFMFP 200	57.600,00€
TFMFP 225	60.480,00€
TFMFP 250	63.500,00€

Opciones | Options | Options

Enganche tripuntal regulable Adjustable 3-point hitch Attelage 3-points réglable	2.750,00€
Rodillo de profundidad con regulación mecánica Depth setting roller with mechanical regulation Rouleau de réglage de profondeur avec régulation mécanique	2.950,00€
Rodillo con regulación de profundidad hidráulica Depth setting roller with hydraulic regulation Rouleau de réglage de profondeur avec régulation hydraulique	5.880,00€
Niveladora trasera con regulación mecánica Rear grader with mechanical regulation Lame niveleuse avec régulation mécanique	3.885,00€
Niveladora trasera con regulación hidráulica Rear grader with hydraulic regulation Lame niveleuse avec régulation hydraulique	9.890,00€
Patines de carretera Road skids Patins pour la route	710,00€
Tercer punto hidráulico Third hydraulic point Troisième point hydraulique	940,00€





**Trituradoras Agrícolas
Agricultural Mulcher
Broyeurs Agricoles**

ML • ELBA



TRITURADORA LIGERA DE MARTILLOS O CUCHILLAS CON DESPLAZAMIENTO MECÁNICO PARA MINITRACTORES. Modelo ML

Máquina ideal para trabajar en agricultura y campos de pastoreo.

Para triturar hasta máximo Ø 3 cm.

Accionamiento con tractores de pequeñas potencias de 18-40 CV.

LIGHTWEIGHT MULCHER WITH HAMMERS OR BLADES, WITH MECHANICAL DISPLACEMENT FOR SMALL TRACTORS. Model ML

Ideal machine for working in agricultural land and grazing grounds.

For mulching till maximum Ø 3 cm.

For small tractors from 18-40 HP power.

BROYEUR LÉGER AVEC MARTEAUX OU LAMES AVEC DÉPORT MÉCANIQUE POUR MICRO-TRACTEURS. MODÈLE ML

Machine spécialement conçue pour l'entretien de pâtures et les travaux agricoles.

Pour broyer des branches de diamètre maxi. 3 cm.

Entraînement par micro-tracteurs de 18 à 40 cv.



		Modelos Model Modèle			
		ML 120	ML 140	ML 160	ML 190
	Revol. min RPM TPM	540	540	540	540
	Ancho trabajo Working width Largeur travail	1200	1400	1600	1850
	Medidas exteriores Outer dimensions Mesures extérieures	A cm. 76 B cm. 138 C cm. 65	76 158 65	76 178 65	76 203 65
	Martillos móviles Swinging Hammers Marteaux oscillants	14	18	24	22
	Peso Weight Poids	265	278	330	395
	Nº Correas Num. Belts Num. Courroies	2	2	2	3
	Potencia tractor (min-max) Tractor power (min-max) Puissance tracteur (min-max)	18-30	20-40	24-40	25-45
	Medidas desplazamiento hidráulico cm. Hydraulic displacements measures cm. Déport hydraulique cm.	76-55 62-83	76-55 82-103	76-55 102-123	76-55 112-133
	Ø mm. Rotor con martillos Ø mm. Rotor with hammers Ø mm. Rotor avec marteaux	270	270	270	270
	Ø cm. máx. tronco Ø cm. máx. trunc Ø cm. max. tronc	3	3	3	3
	Categ. engan. Attach. category Categ. attelage	1a	1a	1a	1a
	Velocidad avance km/h Forward speed km/h Vitesse avancement km/h	3-5	3-5	3-5	3-5
	TFT medidas PTO measures Prise force mesures	1 3/8 z=6	1 3/8 z=6	1 3/8 z=6	1 3/8 z=6
	Protección delantera Front guard Protection frontale	Metálica Metal Métal			
	Protección trasera Back guard Protection arrière	Goma Rubber Gomme			
	Rodillo regulable altura Roller height adjust Rouleau réglable en hauteur	De serie Standard De série			
	Patín protec. chasis Skids chasis protec. Patins protec chasis	De serie Standard De série			

Equipamiento de serie | Standard equipment | Équipement standard

- Patines (2) | Skids (2) | **Patins (2)**
- Rueda libre incluida en el grupo | Freewheel gearbox | **Boitier à roue libre**
- Desplazamiento mecánico | Mechanical displacement | **Déplacement mécanique**

PRECIO | PRICE | PRIX

ML 120	1.866,00€
ML 140	2.216,00€
ML 160	2.380,00€
ML 190	3.635,00€

Opciones | Options | Options

Transmision Transmission Cardan	188,00€
Cilindro y latiguillos para desplazamiento hidráulico Cylinder and hoses for hydraulic displacement Cylindre et flexibles pour le déplacement hydraulique	234,00€

MPT • URAL



TRITURADORA AGRÍCOLA DE MARTILLOS (TIPO CUCHILLAS) CON DESPLAZAMIENTO HIDRÁULICO Y CON PUERTA TRASERA ABATIBLE MODELO MPT

La máquina ideal para trabajar en agricultura, campos de pastoreo y otros. Equipada con un rodillo posterior, enchufes de conexión, desplazamiento hidráulico, regulación en altura, placas protectoras, grupo resistente y transmisión cardan.

Diámetro máximo a triturar: 70 mm.

AGRICULTURAL MULCHER WITH HAMMERS (SIMILAR BLADE TYPE), WITH HYDRAULIC DISPLACEMENT

AND WITH FLIP-UP REAR DOOR MODEL MPT

The ideal machine for working in agricultural land, grazing grounds and others. Equipped with rear roller, connection plugs, hydraulic displacement, adjustable height, zinc plated stone shield, resistant gearbox and drive shaft.

Maximum shredding diameter: 70 mm.

BROYEUR AGRICOLE MODEL MPT A MARTEAUX OU LAMES AVEC DEPORT HYDRAULIQUE ET AVEC PORTE RELEVABLE ARRIÈRE

Machine spécialement étudiée pour l'entretien de pâtures et les travaux agricoles. Équipé de rouleau AR, attelage, déport hydraulique, système de réglage de la hauteur de coupe, boîtier de renvoi d'angle idéalement dimensionné et cardan.

Diamètre maximale de broyage: 70 mm.



Modelos Model Modèle								
	MPT 140	MPT 160	MPT 180	MPT 200	MPT 220	MPT 240	MPT 260	MPT 280
	540	540	540	540	540	540	540	540
	1400	1600	1800	2000	2200	2400	2600	2800
	80 160 83	100 180 89	100 200 89	100 220 89	100 240 89	118 260 120	118 280 120	118 300 120
	18	20	26	26	28	20	22	24
	36 + 18	40 + 20	52	52	56	40	44	48
	354	422	523	690	770	885	932	980
	3	3	4	4	4	5	5	5
	25-45	25-45	35-85	35-85	35-85	70-90	70-90	70-90
	92-70 57-105	60-90 57-125	116-84 74-112	116-104 74-132	116-124 74-152	101-162 143-120	101-182 143-140	101-212 143-170
	2160	2160	2125	2125	2125	2250	2250	2250
	Metálica Metal Métal				Cadena Chain Chaînel			
	Metálica Metal Métal							
	De serie Standard De série							
	De serie Standard De série							

PRECIO | PRICE | **PRIX**

MPT 140	3.605,00€
MPT 160	3.800,00€
MPT 180	4.030,00€
MPT 200	4.880,00€
MPT 220	5.260,00€
MPT 240	5.600,00€
MPT 260	5.900,00€
MPT 280	6.210,00€

Equipamiento de serie | Standard equipment | **Équipement standard**

- Patines (2) | Skids (2) | **Patins (2)**
- Rueda libre incluida en el grupo | Freewheel gearbox | **Boîtier à roue libre**
- Transmision | Transmission | **Cardan**
- Cilindro y latiguillos para desplazamiento hidraulico | Cylinder and hoses for hydraulic displacement | **Cylindre et flexibles pour déplacement hydraulique**



TVA • LOIRE



TRITURADORA AGRÍCOLA TVA

Se caracteriza por su robustez y capacidad de trabajo
Diámetro máximo a triturar: 80 mm.
Altura de trabajo regulable.

AGRICULTURAL MULCHER TVA

Characterized by its strength and working capacity.
Maximum shredding diameter: 80 mm.
Adjustable working height.

BROYEUR AGRICOLE TVA

Se distingue por sa robustesse et sa maniabilité.
Diamètre maximale de broyage : 80 mm.
Système de réglage en hauteur de coupe.



	Modelos Model Modèle										
	TVA 120	TVA 140	TVA 160	TVA 180	TVA 200	TVA 220	TVA 240	TVA 260	TVA 280	TVA 300	TVA 320
	540-1000	540-1000	540-1000	540-1000	540-1000	540-1000	540-1000	540-1000	540-1000	540-1000	540-1000
	1200	1400	1600	1800	2000	2200	2400	2600	2800	3000	1850
	108 140 121	108 160 121	108 180 121	108 200 121	108 220 121	108 240 121	108 260 121	108 280 121	108 300 121	108 320 121	76 340 65
	10	10	12	14	18	20	22	22	22	32	34
	720	750	775	800	830	855	890	935	995	1265	1340
	3 C	3 C	3 C	3 C	3 C	3 C	3 C	3 C	3 C	3 C	3 C
	35-100	40-100	50-100	60-100	60-100	60-100	70-100	80-100	80-100	90-100	90-100
	62-83	62-83	62-83	120-64	200-64	120-80	130-90	140-100	150-110	150-110	160-150
	62-83	62-83	62-83	120-160	120-160	120-160	130-170	140-180	150-190	150-190	160-190
	480	480	480	480	480	480	480	550	550	550	550
	8	8	8	8	8	8	8	8	8	8	8
	1a	2a	2a	2a	2a	2a	2a	2a	2a	2a	2a
	2-7	2-7	2-7	2-7	2-7	2-7	2-7	2-7	2-7	2-7	2-7
	1 3/8 z=6	1 3/8 z=6	1 3/8 z=6	1 3/8 z=6	1 3/8 z=6	1 3/8 z=6	1 3/8 z=6	1 3/8 z=6	1 3/8 z=6	1 3/8 z=6	1 3/8 z=6
	Cadena Chain Chaînel										
	Goma Rubber Gomme										
	De serie Standard De série										
	De serie Standard De série										

Equipamiento de serie | Standard equipment | Équipement standard

· Rueda libre incluida en el grupo | Freewheel gearbox | **Boîtier à roue libre**

PRECIO | PRICE | PRIX

TVA 120	6.290,00€
TVA 140	6.475,00€
TVA 160	6.680,00€
TVA 180	7.150,00€
TVA 200	7.360,00€
TVA 220	7.540,00€
TVA 240	7.800,00€
TVA 260	7.930,00€
TVA 280	8.270,00€
TVA 300	9.810,00€
TVA 320	11.450,00€

Opciones | Options | Options

Transmision Transmission Cardan	380,00€
Desplazamiento hidráulico Hydraulic displacement Déplacement hydraulique	650,00€
2 Ruedas metálicas delanteras 2 Metallic front wheels 2 Roues avant métalliques	600,00€



TVA-R • VISTULA



TRITURADORA AGRÍCOLA TVAR REVERSIBLE

Se caracteriza por su robustez y capacidad de trabajo y por ser reversible.

- Diámetro máximo a triturar: 80mm.
- Altura de trabajo regulable.

AGRICULTURAL MULCHER TVAR REVERSIBLE

Characterized by its strength and working capacity and for to be reversible.

- Maximum shredding diameter: 80mm.
- Adjustable working height.

BROYEUR AGRICOLE TVAR RÉVERSIBLE

Broyeur réversible qui se distingue par sa robustesse et sa capacité à travailler.

- Diamètre maximale de broyage: 80mm.
- Système de réglage en hauteur de coupe.



	Modelos			Model			Modèle		
	TVAR 160	TVAR 180	TVAR 200	TVAR 220	TVAR 240	TVAR 260	TVAR 280	TVAR 300	TVAR 320
	540-1000	540-1000	540-1000	540-1000	540-1000	540-1000	540-1000	540-1000	540-1000
	1600	1800	2000	2200	2400	2600	2800	3000	3200
	108 180 121	108 200 121	108 220 121	108 240 121	108 260 121	108 280 121	108 300 121	108 320 121	108 340 121
	12	14	18	20	22	22	22	32	34
	810	840	870	895	930	975	1035	1305	1380
	3 C	3 C	3 C	3 C	3 C	3 C	3 C	3 C	3 C
	50-100	60-100	60-100	60-100	70-130	80-130	80-140	90-140	90-140
	62-83	62-83	62-83	62-83	120-64	200-64	120-80	130-90	140-100
	62-83	62-83	62-83	62-83	120-160	120-160	120-160	130-170	140-180
	480	480	480	480	480	480	480	480	550
	8	8	8	8	8	8	8	8	8
	1a	1a	2a	2a	2a	2a	2a	2a	2a
	2-7	2-7	2-7	2-7	2-7	2-7	2-7	2-7	2-7
	1 3/8 z=6	1 3/8 z=6	1 3/8 z=6	1 3/8 z=6	1 3/8 z=6	1 3/8 z=6	1 3/8 z=6	1 3/8 z=6	1 3/8 z=6
	Cadena Chain Chaînel								
	Goma Rubber Gomme								
	De serie Standard De série								
	De serie Standard De série								

Equipamiento de serie | Standard equipment | Équipement standard

· Rueda libre incluida en el grupo | Freewheel gearbox | **Boîtier à roue libre**

PRECIO PRICE PRIX	
TVAR 160	7.930,00€
TVAR 180	8.140,00€
TVAR 200	8.350,00€
TVAR 220	8.530,00€
TVAR 240	8.790,00€
TVAR 260	8.920,00€
TVAR 280	9.260,00€
TVAR 300	10.796,50€
TVAR 320	12.440,00€

Opciones | Options | Options

Transmision Transmission Cardan	380,00€
Desplazamiento hidráulico Hydraulic displacement Déplacement hydraulique	650,00€
2 Ruedas metálicas delanteras 2 Metallic front wheels 2 Roues avant métalliques	600,00€

TSF • YUKON



TRITURADORA SEMIFORESTAL TSF

Trituradora semiforestal TSF con doble chapa en el bastidor. Transmisión 1 $\frac{3}{4}$. Para el trabajo de ramas hasta 15 cm. de diámetro. Apropriada para terrenos con piedras.

CARACTERÍSTICAS:

- Se caracteriza por su robustez y gran capacidad de trabajo.
- Diámetro máximo a triturar: 90 mm.
- Altura de trabajo regulable.

OPCIONES:

- Desplazamiento hidráulico.
- Enganche reversible opcional.

SEMI FORESTRY MULCHER TSF

Semi forestry mulcher TSF with double sheet steel frame. Transmission 1 $\frac{3}{4}$. Best suited for branches up to 15 cm. diameter maximum. Suitable for stoned fields.

FEATURES:

- It is characterized by its robustness and high capacity for work.
- Maximum diameter mulching: 90 mm.
- Adjustable working height.

OPTIONS:

- Hydraulic displacement.
- Reversible three point linkage.

BROYEUR SEMI-FORESTIER TSF

Broyeur semi-forestier TSF. Cardan avec double tôle. Cardan 1 $\frac{3}{4}$. Pour broyer branches de 15cm (maximum diamètre). Adapté pour terrains avec des pierres.

CARACTÉRISTIQUES :

- Est caractérisé par sa robustesse et sa maniabilité.
- Diamètre maximum de broyage: 90 mm
- Réglage de la hauteur de coupe.

EN OPTION :

- Déport hydraulique.
- Attelage réversible.



	Modelos			Model	Modèle		
	TSF 160	TSF 180	TSF 200	TSF 220	TSF 240	TSF 260	TSF 280
	540-1000	540-1000	540-1000	540-1000	540-1000	540-1000	540-1000
	1600	1800	2000	2200	2400	2600	2800
	114 180 126	114 200 126	114 220 126	114 240 126	114 260 126	114 280 126	114 300 126
	12	14	18	20	22	22	22
	830	905	945	975	1020	1060	1120
	3 C	3 C	3 C	3 C	4 C	4 C	4 C
	90-150	100-150	100-150	100-150	100-150	110-160	120-180
	123-62 77-138	198-62 122-158	280-64 125-160	280-64 125-160	280-64 125-160	280-64 125-160	280-64 125-160
	570	570	570	570	570	570	570
	9	9	9	9	9	9	9
	2a	2a	2a	2a	2a	2a	2a
	2-7	2-7	2-7	2-7	2-7	2-7	2-7
	1 3/4 z=6	1 3/4 z=6	1 3/4 z=6	1 3/4 z=6	1 3/4 z=6	1 3/4 z=6	1 3/4 z=6
	Cadena Chain Chaînel						
	Metálica Metal Métal						
	De serie Standard De série						
	Opcional Option En option						

Equipamiento de serie | Standard equipment | Équipement standard

· Rueda libre incluida en el grupo | Freewheel gearbox | **Boîtier à roue libre**

PRECIO PRICE PRIX	
TSF 160	7.905,00€
TSF 180	8.165,00€
TSF 200	8.430,00€
TSF 220	8.690,00€
TSF 240	8.950,00€
TSF 260	9.205,00€
TSF 280	9.935,00€

Opciones | Options | Options

Transmision Transmission Cardan	400,00€
Desplazamiento hidráulico Hydraulic displacement Déplacement hydraulique	650,00€
Enganche reversible 2 TFT Reversible 3-point linkage 2 PTO Attelage réversible 2 TFT	1.275,00€
2 Ruedas metálicas delanteras 2 Metallic front wheels 2 Roues avant métalliques	600,00€



TSF-PTH • DUERO

TRITURADORA AGRÍCOLA TSF-PTH

La trituradora TSF-PTH es una máquina muy reforzada con portón trasero para el cribado del material a tratar. El accionamiento del portón se realiza mediante 2 cilindros hidráulicos, y el rodillo va incorporado en el mismo portón. Máquina ideal para la trituración de restos de poda de tamaño medio (ramas de frutales, olivos, almendros y cítricos de hasta 9 cm de diámetro) y de volumen elevado, pudiendo triturar la rama acordonada marcha atrás, para posteriormente dar un repaso de acabado con la puerta cerrada hacia adelante. Y equipada con retenedores ajustables en altura.

AGRICULTURAL MULCHER TSF-PTH

The TSF-PTH mulcher is a highly strengthened machine with a tailgate that serves for screening the material to be treated. The rear door drive is done through 2 hydraulic cylinders, and a roller incorporated in the same door. It's an ideal machine for crushing medium sized pruning remnants of high volume (fruit trees branches, olive trees, almond and citrus of up to 9 cm in diameter) as it can crush sealed-off branches when driving in reverse to subsequently finish the work with door closed forward. It's also equipped with retainers that are adjustable in height.

BROYEUR AGRICOLE TSF-PTH

Le broyeur TSF-PTH est une machine hautement renforcée avec une porte arrière qui sert pour le criblage de la matière à traiter. L'ouvre-portail se fait par 2 vérins hydrauliques et un rouleau incorporé dans la même porte. C'est une machine idéal pour écraser les restes d'élagage de taille moyenne et de volume élevé (branches d'arbres fruitiers, oliviers, amandiers et agrumes de jusqu'à 9 cm. de diamètre), car il peut écraser les branches obturées lors de la conduite en marche arrière, pour après finir le travail avec porte fermée vers l'avant. Il est équipée avec retenues réglables en hauteur.



	Modelos Model Modèle							
	TSF-PTH 140	TSF-PTH 160	TSF-PTH 180	TSF-PTH 200	TSF-PTH 220	TSF-PTH 240	TSF-PTH 260	TSF-PTH 280
	1000	1000	1000	1000	1000	1000	1000	1000
	1400	1600	1800	2000	2200	2400	2600	2800
	120 160 128	120 180 128	120 200 128	120 220 128	120 240 128	120 260 128	120 280 128	120 300 128
	10	12	14	18	20	22	22	22
	840	865	890	920	945	970	1020	1060
	3 C	3 C	3 C	3 C	4 C	4 C	4 C	4 C
	55-110	70-140	80-140	80-140	100-150	100-150	110-160	120-180
	620	620	620	620	620	620	620	620
	9	9	9	9	9	9	9	9
	2a	2a	2a	2a	2a	2a	2a	2a
	1-6	1-6	1-6	1-6	1-6	1-6	1-6	1-6
	1 3/4 z=6	1 3/4 z=6	1 3/4 z=6	1 3/4 z=6	1 3/4 z=6	1 3/4 z=6	1 3/4 z=6	1 3/4 z=6
	Cadena Chain Chaînel							
	Metálica Metal Métal							
	De serie Standard De série							
	De serie Standard De série							

Equipamiento de serie | Standard equipment | Équipement standard

- Patines (2) | Skids (2) | **Patins (2)**
- Rueda libre incluida en el grupo | Freewheel gearbox | **Boîtier à roue libre**
- Transmision | Transmission | **Cardan**
- Desplazamiento hidráulico | Hydraulic displacement | **Déplacement hydraulique**

PRECIO | PRICE | PRIX

TSF PTH 140	9.126,00€
TSF PTH 160	9.510,00€
TSF PTH 180	9.980,00€
TSF PTH 200	10.400,00€
TSF PTH 220	10.850,00€
TSF PTH 240	11.365,00€
TSF PTH 260	11.720,00€
TSF PTH 280	12.140,00€

Opciones | Options | Options

Kit de ruedas delanteras Front wheel kit Kit roues	600,00€
---	---------



M • KAMA

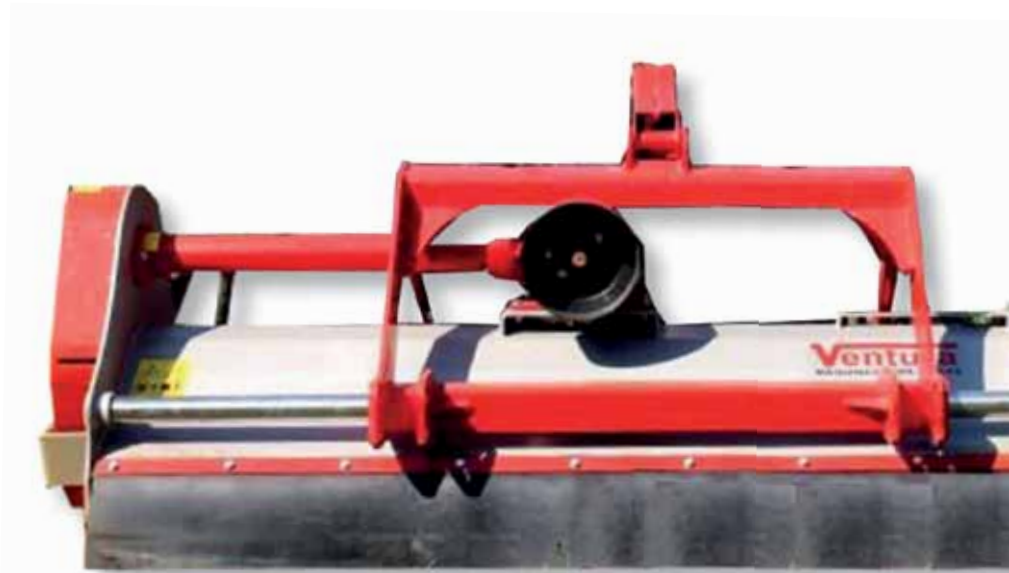

TRITURADORA AGRÍCOLA DE MARTILLOS (tipo cuchillas) CON DESPLAZAMIENTO HIDRÁULICO Y DOBLE ENGANCHE REVERSIBLE Modelo M

La máquina ideal para trabajar en agricultura, campos de pastoreo y otros. Equipada con un rodillo posterior, enchufes de conexión, desplazamiento hidráulico, regulación en altura, placas protectoras, grupo resistente y transmisión cardan.

AGRICULTURAL MULCHER WITH HAMMERS (similar blade type), WITH HYDRAULIC DISPLACEMENT AND DOUBLE REVERSE COUPLING Model M

The ideal machine for working in agricultural land, grazing grounds and others. Equipped with rear roller, connection plugs, hydraulic displacement, adjustable height, zinc plated stone shield, resistant gearbox and drive shaft.

BROYEUR AGRICOLE MODEL M A MARTEAUX OU LAMES AVEC DÉPORT HYDRAULIQUE ET ATTELAGE DOUBLE RÉVERSIBLE Modèle M

Machine spécialement conçue pour l'entretien de pâtures et les travaux agricoles. Équipé de rouleau AR, attelage, déport hydraulique, système de réglage de la hauteur de coupe, boîtier de renvoi d'angle idéalement dimensionné et cardan.



		Modelos Model Modèle			
		M 140	M 180	M 200	M 220
	Revol. min RPM TPM	540-1000	540-1000	540-1000	540-1000
	Ancho trabajo Working width Largeur travail	1500	1700	2000	2200
	Medidas exteriores Outer dimensions Mesures extérieures	A cm. 98 B cm. 174 C cm. 74	98 194 79	98 224 244	98 244 79
	Martillos móviles Swinging Hammers Marteaux oscillants	18	20	16	18
	Peso Weight Poids	440	540	590	665
	Nº Correas Num. Belts Num. Courroies	3	4	4	4
	Potencia tractor (min-max) Tractor power (min-max) Puissance tracteur (min-max)	40-70	50-80	50-90	60-100
	Medidas desplazamiento hidráulico cm. Hydraulic displacements measures cm. Déport hydraulique cm.	99-52 62-109	125-64 79-140	280-64 125-160	125-64 119-180
	Ø mm. Rotor con martillos Ø mm. Rotor with hammers Ø mm. Rotor avec marteaux	340	380	380	380
	Ø cm. máx. tronco Ø cm. máx. trunc Ø cm. max. tronc	7	7	7	7
	Categ. engan. Attach. category Categ. attelage	2a	2a	2a	2a
	Velocidad avance km/h Forward speed km/h Vitesse avancement km/h	2-7	2-7	2-7	2-7
	TFT medidas PTO measures Prise force mesures	1 3/8 z=6	1 3/8 z=6	1 3/8 z=6	1 3/8 z=6
	Protección delantera Front guard Protection frontal	Cadena Chain Chaînel			
	Protección trasera Back guard Protection arrière	Goma Rubber Gomme			
	Rodillo regulable altura Roller height adjust Rouleau réglable en hauteur	De serie Standard De série			
	Patín protecc. chasis Skids chasis protec. Patins protec chasis	De serie Standard De série			

Equipamiento de serie | Standard equipment | Équipement standard

- Patines (2) | Skids (2) | **Patins (2)**
- Rueda libre incluida en el grupo | Freewheel gearbox | **Boîtier à roue libre**
- Desplazamiento mecánico | Mechanical displacement | **Déplacement mécanique**

PRECIO | PRICE | PRIX

M 140	3.166,00€
M 180	4.017,00€
M 200	4.400,50€
M 220	4.940,00€

Opciones | Options | Options

Transmision I Transmission Cardan	227,50€
Cilindro y latiguillos para desplazamiento hidráulico Cylinder and hoses for hydraulic displacement Cylindre et flexibles pour le déplacement hydraulique	286,00€

TSFE • MIN



TRITURADORA SEMIFORESTAL TSFE

Trituradora semiforestal con doble chapa en el bastidor. Transmisión 1 3/8. Para el trabajo de ramas hasta 8 cm de diámetro. Apropriada para terrenos con piedras.

CARACTERÍSTICAS:

- Se caracteriza por su robustez y gran capacidad de trabajo.
- Altura de trabajo regulable.

OPCIONES:

- Desplazamiento hidráulico.
- Enganche reversible opcional.

SEMI FORESTRY MULCHER TSFE

Semi forestry mulcher TSFE with double sheet steel frame. Transmission 1 3/8. Best suited for branches up to 8 cm. diameter maximum. Suitable for stoned fields.

FEATURES:

- It is characterized by its robustness and high capacity for work.
- Adjustable working height.

OPTIONS:

- Hydraulic displacement.
- Reversible three point linkage.

BROYEUR SEMI-FORESTIER TSFE

Broyeur semi-forestier TSFE. Cardan avec double tôle. Cardan 1 3/8. Pour broyer branches de 8cm (maximum diamètre). Adapté pour terrains avec des pierres.

CARACTÉRISTIQUES:

- Est caractérisé par sa robustesse et sa maniabilité.
- Réglage de la hauteur de coupe.

EN OPTION:

- Déport hydraulique.
- Attelage réversible.



		Modelos	Model	Modèle
		TSFE 200	TSFE 220	TSFE 240
	Revol. min RPM TPM	540-1000	540-1000	540-1000
	Ancho trabajo Working width Largeur travail	2000	2200	2400
	Medidas exteriores Outer dimensions Mesures extérieures	A cm. 1100 B cm. 2200 C cm. 1200	1100 2400 1200	1100 2600 1200
	Martillos móviles Swinging Hammers Marteaux oscillants	18	20	22
	Peso Weight Poids	800	830	860
	Nº Correas Num. Belts Num. Courroies	3C	3C	3C
	Potencia tractor (min-max) Tractor power (min-max) Puissance tracteur (min-max)	65-150	70-150	75-160
	Medidas desplazamiento hidráulico cm. Hydraulic displacements measures cm. Déport hydraulique cm.	850 2300	1050 2500	1250 2700
	Ø mm. Rotor con martillos Ø mm. Rotor with hammers Ø mm. Rotor avec marteaux	480	480	480
	Ø cm. máx. tronco Ø cm. máx. trunc Ø cm. max. tronc	8	8	8
	Categ. engan. Attach. category Categ. attelage	2a	2a	2a
	Velocidad avance km/h Forward speed km/h Vitesse avancement km/h	2-7	2-7	2-7
	TFT medidas PTO measures Prise force mesures	1 3/4 z=6	1 3/4 z=6	1 3/4 z=6
	Protección delantera Front guard Protection frontal	Cadena Chain Chaînel		
	Protección trasera Back guard Protection arrière	Goma Rubber Gomme		
	Rodillo regulable altura Roller height adjust Rouleau réglable en hauteur	De serie Standard De série		
	Patín protecc. chasis Skids chasis protec. Patins protec chasis	Opcional Option En option		



Equipamiento de serie | Standard equipment | Équipement standard

· Rueda libre incluida en el grupo | Freewheel gearbox | **Boitier à roue libre**

PRECIO | PRICE | PRIX

TSFE 200	9.050,00€
TSFE 220	9.126,00€
TSFE 240	9.425,00€

Opciones | Options | Options

2 ruedas metálicas delanteras 2 metallic front wheels 2 roues avant métalliques	405,00€
--	---------

TRIN • VOLGA



TRINCHADORA LATERAL Y GENERAL

La trinchadora de desplazamiento lateral, permite trabajar con la totalidad de la máquina al exterior del tractor. Las características técnicas de esta máquina la hacen particularmente adecuada para trabajar en cunetas de carretera, márgenes y en casos donde el tractor no pueda transitar en la zona a desmalezar.

Diámetro máximo a triturar: 70 mm.

LATERAL SHREDDER AND GENERAL

Shredder with lateral displacement that lets you work with the whole machine outside from the tractor. The technical features of this machine make them particularly adequate for working at road ditches, margins and places where the tractor cannot reach the area that has to be mulched.

Maximum shredding diameter: 70 mm.

BROYEUR LATÉRAL ET AXIAL

Ce broyeur latéral permet de travailler complètement à l'extérieur du tracteur. Le modèle TRIN est étudié pour travailler les accotements, les fossés, et atteindre les zones difficiles d'accès pour le tracteur.

Diamètre maximale de broyage: 70 mm.

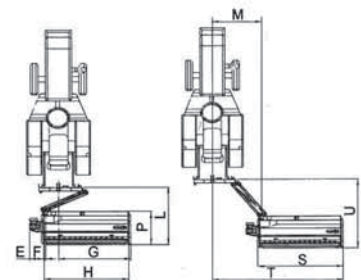
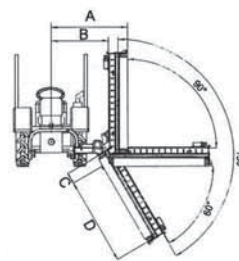

*TRIN 121-141 (GRUPO INTERIOR / INNER GEARBOX / INTERIEURE)

*TRIN 161-221 (GRUPO EXTERIOR / OUTER GEARBOX / EXTÉRIEURE)

	A (cm)	B (cm)	C (cm)	D (cm)	E (cm)	F (cm)	G (cm)	L (cm)	H (cm)	M (cm)	P (cm)	S (cm)	T (cm)	B (cm)
TRIN 121	131	89	26	101	36	5	125	150	125	97	84	166	193	175
TRIN 141	131	89	26	121	36	5	145	150	145	97	84	186	212	175
TRIN 161	131	89	26	141	36	5	165	150	165	97	84	206	261	175
TRIN 181	173	130	25	160	39	6	152	145	198	138	79	230	325	182
TRIN 201	173	130	25	180	39	6	172	145	218	138	79	250	345	182
TRIN 221	173	130	25	200	39	6	192	145	238	138	79	270	365	182



Modelos Model Modèle							
	TRIN 121	TRIN 141	TRIN 161	TRIN 181	TRIN 201	TRIN 221	
	540	540	540	540	540	540	
	1200	1400	1600	1800	2000	2350	
	98 179 150	98 179 150	98 199 150	105 248 145	105 268 145	105 288 145	
	18	18	20	14	16	18	
	285	405	465	680	700	795	
	2	3	3	4	4	4	
	25-45	40-60	50-80	50-80	55-100	60-100	
	270	340	340	380	380	380	
	3	7	7	7	7	7	
	1a	1a 2a	1a 2a	2a	2a	2a	
	3-5	1-6	1-6	1-6	1-6	1-6	
	1 3/8 z=6	1 3/8 z=6	1 3/8 z=6	1 3/8 z=6	1 3/8 z=6	1 3/8 z=6	
	Metálica Metal Métal			Cadena Chain Chaînel			
	Goma Rubber Gomme						
	De serie Standard De série						
	De serie Standard De série						

PRECIO | PRICE | PRIX

TRIN 121	3.550,00€
TRIN 141	4.330,00€
TRIN 161	5.030,00€
TRIN 181	6.235,00€
TRIN 201	6.580,00€
TRIN 221	6.930,00€

Equipamiento de serie | Standard equipment | Équipement standard

- Transmision | Transmission | **Cardan**
- Patines (2) | Skids (2) | **Patins (2)**
- Rueda libre incluida en el grupo | Freewheel gearbox | **Boîtier à roue libre**

Opciones | Options | Options

Transmisión homocinética (doble nudo)	
CV transmission (double knot)	
CV cardan (double noeud)	850,00€



TRIN R • TURIA



TRINCHADORA LATERAL Y GENERAL (GRUPO INTERIOR)

La trinchadora de desplazamiento lateral, permite trabajar con la totalidad de la máquina al exterior del tractor. Las características técnicas de esta máquina la hacen particularmente adecuada para trabajar en cunetas de carretera, márgenes y en casos donde el tractor no pueda transitar en la zona a desmalezar.

Diámetro máximo a triturar: 80 mm.

LATERAL SHREDDER AND GENERAL (INNER GEARBOX)

Shredder with lateral displacement that lets you work with the whole machine outside from the tractor. The technical features of this machine make them particularly adequate for working at road ditches, margins and places where the tractor cannot reach the area that has to be mulched.

Maximum shredding diameter: 80 mm.

BROYEUR LATÉRAL ET DU CENTRE (BOITIER INTÉRIEURE)

Le broyeur latéral permet travailler pleinement avec la machine à l'extérieur du tracteur. Le broyeur modèle TRIN est adapté pour travailler dans accotements, bas-côtés et de cas où le tracteur ne peut se déplacer dans le désherbage.

Diamètre maximale de broyage: 80 mm.



Dimensiones y Alcances	A	B	C	D	E	F	G	H	I	J
TRIN-R 160	1600	1730	830	1070	2328	808	2120	1890	1195	810
TRIN-R 180	1800	1930	830	1070	2528	808	2120	1890	1395	810
TRIN-R 200	2000	2130	830	1070	2728	808	2120	1890	1595	810
TRIN-R 220	2200	2330	830	1070	2928	808	2120	1890	1795	810
TRIN-R 240	2400	2530	830	1070	3125	808	2120	1890	1995	810

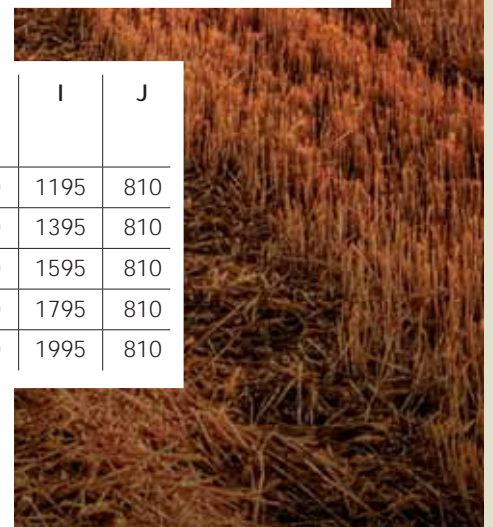

		Modelos Model Modèle				
		TRIN R 160	TRIN R 180	TRIN R 200	TRIN R 220	TRIN R 240
	Revol. min RPM TPM	540-1000	540-1000	540-1000	540-1000	540-1000
	Ancho trabajo Working width Largeur travail	1600	1800	2000	2200	2400
	Medidas exteriores Outer dimensions Mesures extérieures	A cm. 173 B cm. 87 C cm. 87	93 193 87	96 213 87	99 233 87	102 253 87
	Martillos móviles Swinging Hammers Marteaux oscillants	12	14	16	18	22
	Peso Weight Poids	885	982	1030	1075	1190
	Nº Correas Num. Belts Num. Courroies	3 C	3 C	3 C	3 C	3 C
	Potencia tractor (min-max) Tractor power (min-max) Puissance tracteur (min-max)	80-120	80-120	80-130	90-140	100-150
	Ø mm. Rotor con martillos Ø mm. Rotor with hammers Ø mm. Rotor avec marteaux	480	480	480	480	480
	Ø cm. máx. tronco Ø cm. máx. trunc Ø cm. max. tronc	8	8	8	8	8
	Categ. engan. Attach. category Categ. attelage	2a	2a	2a	2a	2a
	Velocidad avance km/h Forward speed km/h Vitesse avancement km/h	1-6	1-6	1-6	1-6	1-6
	TFT medidas PTO measures Prise force mesures	1 3/4 z=6	1 3/4 z=6	1 3/4 z=6	1 3/4 z=6	1 3/4 z=6
	Protección delantera Front guard Protection frontal	Metálica Metal Métal				
	Protección trasera Back guard Protection arrière	Metálica Metal Métal				
	Rodillo regulable altura Roller height adjust Rouleau réglable en hauteur	De serie Standard De série				
	Patín protecc. chasis Skids chasis protec. Patins protec chasis	De serie Standard De série				

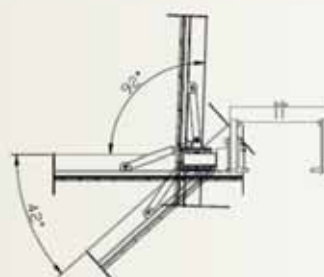
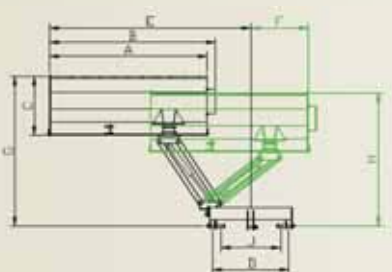

Equipamiento de serie | Standard equipment | Équipement standard

- Transmisión | Transmission | **Cardan**
- Patines (2) | Skids (2) | **Patins (2)**
- Rueda libre incluida en el grupo | Freewheel gearbox | **Boîtier à roue libre**

PRECIO | PRICE | PRIX

TRIN R 160	9.680,00€
TRIN R 180	9.940,00€
TRIN R 200	10.195,00€
TRIN R 220	10.460,00€
TRIN R 240	10.720,00€

Opciones | Options | Options

Transmisión homocinética (doble nudo) CV transmission (double knot) CV Cardan (double noeud)	850,00€
---	---------

TRIN R-E • SENA



TRINCHADORA LATERAL (GRUPO EXTERIOR)

La trinchadora de desplazamiento lateral, permite trabajar con la totalidad de la máquina al exterior del tractor. Las características técnicas de esta máquina la hacen particularmente adecuada para trabajar en cunetas de carretera, márgenes y en casos donde el tractor no pueda transitar en la zona a desmalezar.

LATERAL SHREDDER (OUTER GEARBOX)

Shredder with lateral displacement that lets you work with the whole machine outside from the tractor. The technical features of this machine make them particularly adequate for working at road ditches, margins and places where the tractor cannot reach the area that has to be mulched.

BROYEUR LATÉRAL (GROUPE EXTERIEUR)

Le broyeur latéral permet travailler pleinement avec la machine à l'extérieur du tracteur. Le broyeur est adapté pour travailler dans accotements, bas-côtés et de cas où le tracteur ne peut se déplacer dans le désherbage.

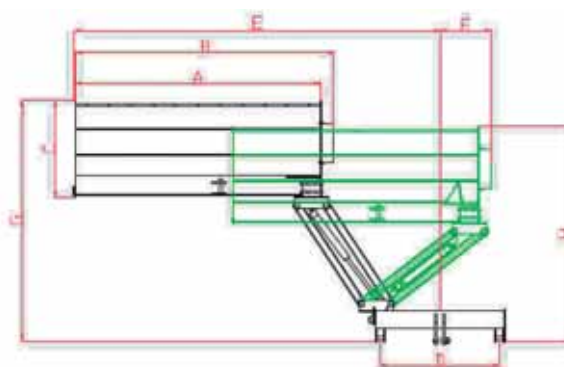

	A (mm)	B (mm)	C (mm)	D (mm)	E (mm)	F (mm)	G (mm)	H (mm)
TRIN R-E 160	1600	2100	830	1070	2640	825	2100	1900
TRIN R-E 180	1800	2300	830	1070	2840	825	2100	1900
TRIN R-E 200	2000	2500	830	1070	3040	825	2100	1900
TRIN R-E 220	2200	2700	830	1070	3240	825	2100	1900
TRIN R-E 240	2400	2900	830	1070	3440	825	2100	1900

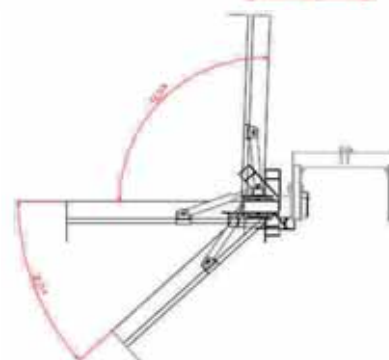

		Modelos Model Modèle				
		TRIN R-E 160	TRIN R-E 180	TRIN R-E 200	TRIN R-E 220	TRIN R-E 240
	Revol. min RPM TPM	540-1000	540-1000	540-1000	540-1000	540-1000
	Ancho trabajo Working width Largeur travail	1600	1800	2000	2200	2400
	Medidas exteriores Outer dimensions Mesures extérieures	A cm. 117 B cm. 180 C cm. 152	117 200 152	117 220 152	117 240 152	117 260 152
	Martillos móviles Swinging Hammers Marteaux oscillants	12	14	16	18	22
	Peso Weight Poids	885	982	1030	1075	1190
	Nº Correas Num. Belts Num. Courroies	3 C	3 C	3 C	3 C	3 C
	Potencia tractor (min-max) Tractor power (min-max) Puissance tracteur (min-max)	80-120	80-120	80-130	90-140	100-150
	Ø mm. Rotor con martillos Ø mm. Rotor with hammers Ø mm. Rotor avec marteaux	480	480	480	480	480
	Ø cm. máx. tronco Ø cm. máx. trunc Ø cm. max. tronc	8	8	8	8	8
	Categ. engan. Attach. category Categ. attelage	2a	2a	2a	2a	2a
	Velocidad avance km/h Forward speed km/h Vitesse avancement km/h	1-6	1-6	1-6	1-6	1-6
	TFT medidas PTO measures Prise force mesures	1 3/4 z=6	1 3/4 z=6	1 3/4 z=6	1 3/4 z=6	1 3/4 z=6
	Protección delantera Front guard Protection frontale	Metálica Metal Métal				
	Protección trasera Back guard Protection arrière	Metálica Metal Métal				
	Rodillo regulable altura Roller height adjust Rouleau réglable en hauteur	De serie Standard De série				



PRECIO | PRICE | PRIX

TRIN R-E 160	10.750,00€
TRIN R-E 180	11.020,00€
TRIN R-E 200	11.290,00€
TRIN R-E 220	11.560,00€
TRIN R-E 240	11.830,00€

Opciones | Options | Options

Transmisión homocinética (simple) CV transmission (simple)	
CV Cardan (simple)	730,00€
Kit Patines delanteros Front skates kit	
Patins	154,00€

TRIN PRO • CENIA



Trinchadora Lateral (grupo central) La trinchadora de desplazamiento lateral TRIN PRO para trabajo pesado, ofrece anchos de trabajo de 175 a 215cm, enlace de 3 puntos Cat II, ajustador de correas completamente automático, rueda libre en la caja de engranajes, desplazamiento lateral hidráulico, cilindro hidráulico para posicionamiento de la cabeza (+ 90° / -50°), Adecuado para 80 - 100 HP tractor. Esta trinchadora es adecuada para segar y triturar hierba, matorrales, vegetación pesada y ramas de hasta Ø6 cm, en aplicaciones difíciles como la carretera, pendientes, zanjas, ríos, canales, campos abiertos, etc.

Lateral shredder (central group) TRIN - VOLGA Shredder with lateral displacement TRIN PRO for heavy-duty, offers working widths from 175 to 215cm, 3-Point linkage Cat II, full automatic belts adjuster, free wheel in the gearbox, hydraulic side shift, hydraulic cylinder for head positioning (+90°/-50°). Suited for 80 - 100 HP tractor. This shredder is suited to mowing and crushing grass, brush, heavy vegetation and branches up to Ø6 cm, on tough applications such as road-side, slopes, ditches, rivers, canals, open fields etc.

Broyeur latéral (groupe central) La trancheuse à déplacement latéral robuste TRIN PRO offre des largeurs de travail de 175 à 215 cm, une liaison 3 points Cat II, un dispositif de réglage de la courroie entièrement automatique, une roue libre dans la boîte de vitesses, un déplacement hydraulique latéral, vérin hydraulique pour le positionnement de la tête (+ 90° / -50°), Convient pour un tracteur de 80 à 100 CV. Ce sculpteur convient pour tondre et broyer l'herbe, les buissons, la végétation lourde et les branches jusqu'à Ø6 cm, dans des applications difficiles telles que la route, les pentes, les fossés, les rivières, les canaux, les champs ouverts, etc.



		Modelos Model Modèle		
		TRIN PRO 180	TRIN PRO 200	TRIN PRO 220
	Categ. engan. Attach. category Categ. attelage	2ª	2ª	2ª
	Martillos móviles Swinging hammers Marteaux oscillants	16	18	20
	Revol. min. RPM RPM	540	540	540
	∅ cm. máx. tronco ∅ cm. máx. trunc ∅ cm. max. tronc	6	6	6
	Nº Correas Num. Belts Num. Courroies	5	5	5
	Peso Weight Poids	875	897	917
	Potencia tractor (min-max) Tractor power (min-max) Puissance tracteur (min-max)	80-100	80-100	80-100
	Ancho trabajo (mm) Working width (mm) Largeur travail (mm)	1750	1950	2150

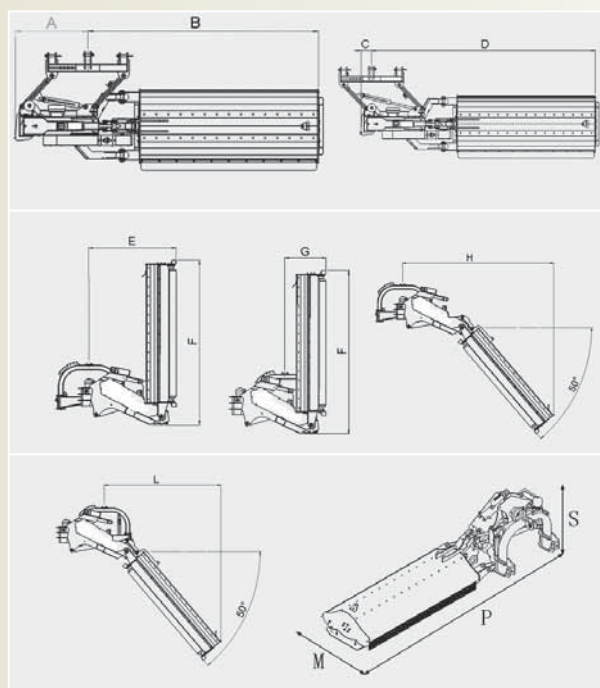

	A (mm)	B (mm)	C (mm)	D (mm)	E (mm)	F (mm)	G (mm)	L (mm)	H (mm)	M (mm)	P (mm)	S (mm)
TRIN PRO 180	900	2460	170	3180	1390	2230	667	1780	2520	1400	3420	1080
TRIN PRO 200	900	2660	170	3380	1390	2430	667	1980	2720	1400	3620	1080
TRIN PRO 220	900	2860	170	3580	1390	2630	667	2180	2920	1400	3820	1080

PRECIO | PRICE | PRIX

TRIN PRO 180	8.745,00€
TRIN PRO 200	9.177,00€
TRIN PRO 220	9.980,00€

TGS • EBRO | TGSD • GRANDE

TRITURADORA AGRÍCOLA DE MARTILLOS DE MAIZ – CEREAL – HIERBA Y PARA GRANDES SUPERFICIES TGS / TGSD

Trituradora para grandes superficies con doble chapa en el bastidor. Transmisión 1 3/4. Para el trabajo de ramas hasta 9 cm. de diámetro. Apropriada para terrenos con piedras.

CARACTERÍSTICAS: Se caracteriza por su robustez y gran capacidad de trabajo. Diámetro máximo a triturar: 150 mm. Altura de trabajo regulable. Transmisión por correas.

OPCIONES: Desplazamiento hidráulico. Enganche reversible opcional.

AGRICULTURAL MULCHER WITH HAMMERS CORN – CEREAL – GRASS AND FOR BIG SURFACES TGS / TGSD

Mulcher for big surfaces with double sheet steel frame. Transmission 1 3/4. Best suited for branches up to 9 cm. maximum diameter. Suitable for stoned fields.

FEATURES: It is characterized by its robustness and high capacity for work. Maximum mulching diameter: 150 mm. Adjustable working height. Transmission with belt drives.

OPTIONS: Hydraulic displacement. Reversible three point linkage.

BROYEUR AGRICOLE À MARTEAUX MAÏS – CÉREALES – GRASS POUR LES GRANDES SURFACES TGS / TGSD

Broyeur pour les grandes surfaces avec doublé tôle. Cardan 1 3/4. Pour broyer branches de 9 cm (diamètre maximale). Adapté pour terrains avec des pierres.

CARACTÉRISTIQUES: Est caractérisé par sa robustesse et sa maniabilité. Diamètre maximum de broyage: 150 mm. Réglage de la hauteur de coupe. Entraînement par courroie.

EN OPTION: Déport hydraulique. Attelage réversible.



		Modelos			Model	Modèle		
		TGS 260	TGS 280	TGS 300	TGS 320	TGSD 350	TGSD 370	TGSD 400
		540-1000	540-1000	540-1000	540-1000	1000	1000	1000
		2600	2800	3000	3200	3500	3700	4000
		121 284 132	121 304 132	121 324 132	121 344 132	121 374 132	121 394 132	121 424 132
		22	22	24	26	28	30	34
		965	1065	1175	1265	1955	2135	2285
		4	4	4	4	8	8	8
		110-150	120-160	130-170	130-180	140-190	140-190	150-200
		620	620	620	620	620	620	620
		9	9	9	9	9	9	9
		2a	2a	2a	2a	2a	2a	2a
		1-6	1-6	1-6	1-6	1-6	1-6	1-6
		1 3/4 z=6	1 3/4 z=6	1 3/4 z=6	1 3/4 z=6	1 3/4 z=6	1 3/4 z=6	1 3/4 z=6
		Cadena Chain Chainel						
		Criba metálica Metal screen Écran métal						
		Ruedas pneumá. Pneuma wheels Roues pneuma.						
		Opcional Option En option						

PRECIO | PRICE | PRIX

TGS 260	10.980,00€
TGS 280	11.370,00€
TGS 300	11.630,00€
TGS 320	12.020,00€
TGSD 350	17.610,00€
TGSD 370	20.530,00€
TGSD 400	21.350,00€

Equipamiento de serie | Standard equipment | Équipement standard

· Rueda libre incluida en el grupo | Freewheel gearbox | **Boîtier à roue libre**

Opciones | Options | Options

Transmision | Transmission | **Cardan** 495,00€



TAV • TAJO

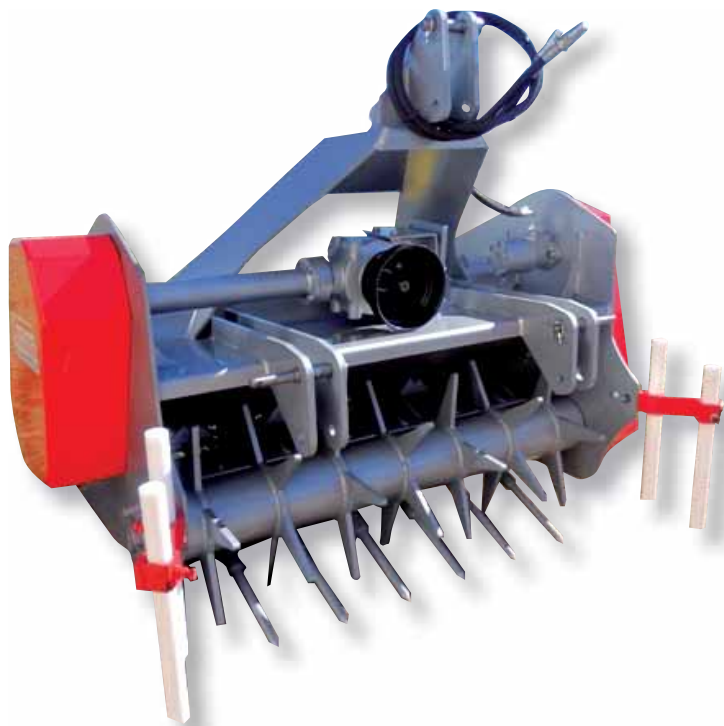

TRITURADORA AUTOALIMENTADA TAV PICK UP PARA TRONCOS HASTA 4 CM Ø

El sistema de alimentación con 1 pick up hidráulico mediante el cual entran dosificadas en la trituradora. El bastidor de la máquina incorpora una pantalla desmontable. El material resultante es muy uniforme en medidas y es un excelente abono para el suelo.

EQUIPAMIENTO DE SERIE: 1 pick up hidráulico i criba desmontable

SELF-SUPPLIED MULCHER WITH PICK-UP, FOR LOGS UP TO Ø 4 CM

Power system with 1 hydraulic pick-up, that will place the branches into the crusher. The frame of the machine includes a detachable screen. The resulting material is very uniform in dimensions and is excellent compost for the soil.

STANDARD EQUIPMENT: 1 hydraulic pick up and detachable screen

BROYEUR AUTO-ALIMENTÉE PAR PICK-UP POUR DIAMÈTRE MAXI 4 CM

Machine idéalement étudiée pour le broyage de sarments de vignes et branches de vergers, grâce au pick-up à entraînement hydraulique qui ramène la matière à l'intérieur du broyeur, en quantité constante. Le broyat obtenu est très régulier et devient un très bon engrais pour le sol. Livré avec un capot de protection amovible.

Équipement standard: 1 pick up hydraulique et écran détachable.



Modelos Model Modèle							
	TAV 85	TAV 100	TAV 125	TAV 140	TAV 160	TAV 180	
	540	540	540	540	540	540	
	850	1000	1250	1400	1600	1800	
	130 115 153	130 130 153	130 155 153	130 170 153	130 190 153	130 210 153	
	8	8	10	10	12	14	
	560	610	675	730	775	840	
	3B+3B	3B+3B	3B+3B	3B+3B	3B+3B	3B+3B	
	40-100	40-100	50-120	60-120	70-120	80-130	
	480	480	480	480	480	480	
	4	4	4	4	4	4	
	1a	1a	1a	1a	1a	1a	
	2-5	2-5	2-5	2-5	2-5	2-5	
	1 3/8 z=6	1 3/8 z=6	1 3/8 z=6	1 3/8 z=6	1 3/8 z=6	1 3/8 z=6	
	Criba metálica Metal screen Écran métal						
	Ruedas pneumá. Pneuma wheels Roues pneuma.						

PRECIO | PRICE | **PRIX**

TAV 85	9.160,00€
TAV 100	9.420,00€
TAV 125	9.680,00€
TAV 140	9.940,00€
TAV 160	10.200,00€
TAV 180	10.460,00€

Equipamiento de serie | Standard equipment | **Équipement standard**

- pick up mecánico | 1 mechanic pick up | **Système de 1 pick ups mécanique**
- Criba desmontable | Detachable screen | **Écran détachable**

Opciones | Options | **Options**

Transmision Transmission Cardan	370,00€
--	---------



TAV-O • LENA

TRITURADORA AUTOALIMENTADA TAV PICK UP PARA TRONCOS HASTA 10 CM Ø

Es la máquina ideal para triturar los restos de caña, de oliva, cítricos y frutas. El sistema de autoalimentación puede con todo tipo de ramas de olivo de hasta 10 cm de diámetro. Sistema de alimentación con dos pick ups hidráulicos mediante el cual las ramas entran dosificadas en la trituradora. El bastidor de la máquina incorpora una pantalla desmontable. El material resultante es muy uniforme en medidas y es un excelente abono para el suelo.

EQUIPAMIENTO DE SERIE: 2 pick up hidráulicos i criba desmontable.

OPCIONES: Volante de inercia, enganche reversible 2 TFT.

SELF-SUPPLIED MULCHER WITH PICK UP OR LOGS UP TO Ø 10 CM

Suitable for remnants of crane, olives, citrus and fruits. Unique pick-up system that can crush branches of olive tree up to 10 cm diameter. Power system with two hydraulic pick-ups that will place the branches into the crusher. The machine frame features a removable screen. The resulting material is very uniform in dimensions and is an excellent compost for the soil.

STANDARD EQUIPMENT: 2 hydraulic pick up and detachable screen

OPTIONS: Flywheel, reversible 3 point linkage 2 PTO.

BROYEUR AUTO-ALIMENTEE PAR PICK-UP POUR DIAMETRE MAXI 10 CM

C'est la machine idéale pour écraser les restes de canne, d'olive, d'agrumes et de des fruits Le système d'auto-alimentation peut être utilisé avec toutes sortes de branches olivier jusqu'à 10 cm de diamètre. Système d'alimentation à deux capteurs hydrauliques au moyen desquels les branches entrent dosifi é dans le concasseur Le châssis de la machine intègre un écran amovible. Le matériau obtenu présente des mesures très uniformes et constitue un excellent engrais de sol

ÉQUIPEMENT DE SÉRIE: 2 capteurs hydraulique et écran amovible.

OPTIONS: Volant moteur, attelage réversible 2 TFT.



		Modelos	Model	Modèle
		TAV-O 160	TAV-O 180	TAV-O 200
	Revol. min RPM TPM	1000	1000	1000
	Ancho trabajo Working width Largeur travail	1600	1800	2000
	Medidas exteriores Outer dimensions Mesures extérieures	A cm. 134 B cm. 185 C cm. 158	134 215 158	134 235 158
	Martillos móviles Swinging Hammers Marteaux oscillants	72	78	90
	Peso Weight Poids	1350	1440	1580
	Nº Correas Num. Belts Num. Courroies	3 C	3 C	3 C
	Potencia tractor (min-max) Tractor power (min-max) Puissance tracteur (min-max)	50-110	70-110	80-130
	Ø mm. Rotor con martillos Ø mm. Rotor with hammers Ø mm. Rotor avec marteaux	560	560	560
	Ø cm. máx. tronco Ø cm. máx. trunc Ø cm. max. tronc	10	10	10
	Categ. engan. Attach. category Categ. attelage	2a	2a	2a
	Velocidad avance km/h Forward speed km/h Vitesse avancement km/h	1-4	1-4	1-4
	TFT medidas PTO measures Prise force mesures	1 3/4 z=6	1 3/4 z=6	1 3/4 z=6
	Protección trasera Back guard Protection arrière	Criba metálica Metal screen Écran métal		
	Rodillo regulable altura Roller height adjust Rouleau réglable en hauteur	Ruedas neumá. Pneuma wheels Roues pneuma.		

PRECIO | PRICE | PRIX

TAV-O 160	14.580,00€
TAV-O 180	15.120,00€
TAV-O 200	15.525,00€

Equipamiento de serie | Standard equipment | Équipement standard

- Transmision | Transmission | **Cardan**
- 2 pick up hidráulicos | 2 hydraulic pick up | **Système de 2 pick ups hydrauliques**
- Criba desmontable | Detachable screen | **Écran détachable**

Opciones | Options | Options

Enganche reversible 2 TFT Reversible 3-point linkage 2 PTO Attelage réversible 2 TFT	972,00€
---	---------



TGDA • JAMES

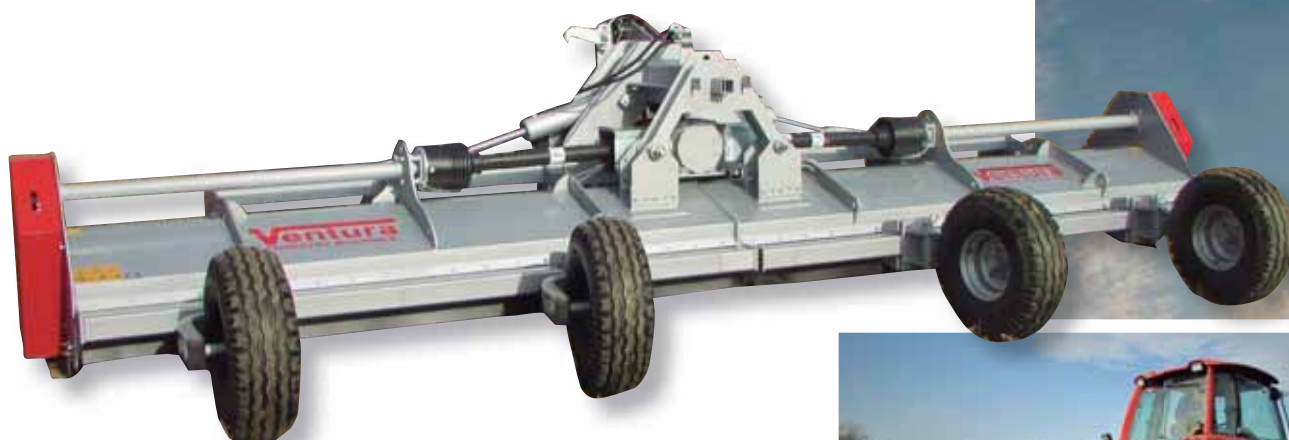

TRITURADORA DE ALTO RENDIMIENTO PLEGABLE

- Ø del rotor de 3,60 a 4,80 m: 180 mm
- Ø del rotor de 5,20 a 6,40 m: 220 mm
- Caja de cambios con rueda libre
- Varillaje de tres puntos cat. 2 con barra de fijación rápida
- Engrasador centralizado
- Tensor automático del cinturón
- 2 contracuchillas
- Patines
- Bloqueo mecánico en pistones hidráulicos para transporte















HIGH PERFORMANCE FOLDING CRUSHER

- Rotor Ø from 3,60 to 4,80 m: 180 mm
- Rotor Ø from 5,20 to 6,40 m: 220 mm
- Gearbox with free wheel
- Three point linkage cat. 2 with rapid attachment bar
- Centralised greaser
- Automatic belt tightener
- 2 counter-knife
- Skids
- Mechanical locking on hydraulic pistons for transport

BROYEUR PLIANT HAUTE PERFORMANCE

- Ø de rotor de 3,60 à 4,80 m: 180 mm
- Ø de rotor de 5,20 à 6,40 m: 220 mm
- Boîte de vitesses avec roue libre
- Attelage trois points cat. 2 avec barre de fixation rapide
- Graisseur centralisé
- Tendeur automatique de courroie
- 2 contre-couteaux
- Patins
- Verrouillage mécanique des pistons hydrauliques pour le transport



	Modelos			Model		Modèle		
	TGDA 365	TGDA 405	TGDA 445	TGDA 485	TGDA 525	TGDA 565	TGDA 605	TGDA 645
	1000	1000	1000	1000	1000	1000	1000	1000
	360	400	440	480	520	560	600	640
	400	440	480	520	560	600	640	680
	250	250	250	250	250	250	250	250
	72	80	88	96	104	112	120	128
	36	40	44	48	52	56	60	64
	1892	2037	2112	2291	2432	2522	2602	2702
	8	8	8	8	10	10	10	10
	90	110	120	130	150	160	160	180
	490	490	490	490	530	530	530	530
	70	70	70	70	70	70	70	70
	2a	2a	2a	2a	2a	2a	2a	2a
	2-10	2-10	2-10	2-10	2-10	2-10	2-10	2-10
	1 3/8 z=6	1 3/8 z=6	1 3/8 z=6	1 3/8 z=6	1 3/8 z=6	1 3/8 z=6	1 3/8 z=6	1 3/8 z=6
	4 Ruedas neumá. Pneuma wheels Roues pneuma. 8.00-15							

PRECIO | PRICE | PRIX

TGDA 365	26.550,00€
TGDA 405	27.165,00€
TGDA 445	27.340,00€
TGDA 485	32.980,00€
TGDA 525	34.110,00€
TGDA 565	35.150,00€
TGDA 605	31.105,00€
TGDA 645	32.460,00€

Equipamiento de serie | Standard equipment | Équipement standard

· Rueda libre incluida en el grupo | Freewheel gearbox | Boîtier à roue libre

Opciones | Options | Options

Transmision Transmission Cardan	895,00€
Kit de 4 ruedas 8.00-15 pivotantes 4-wheel pivoting kit 8.00-15 Kit de pivotement aux 4 roues 8.00-15	2.080,00€
Fijador hidráulico Hydraulic fixator Fixateur hydraulique	1.432,00€

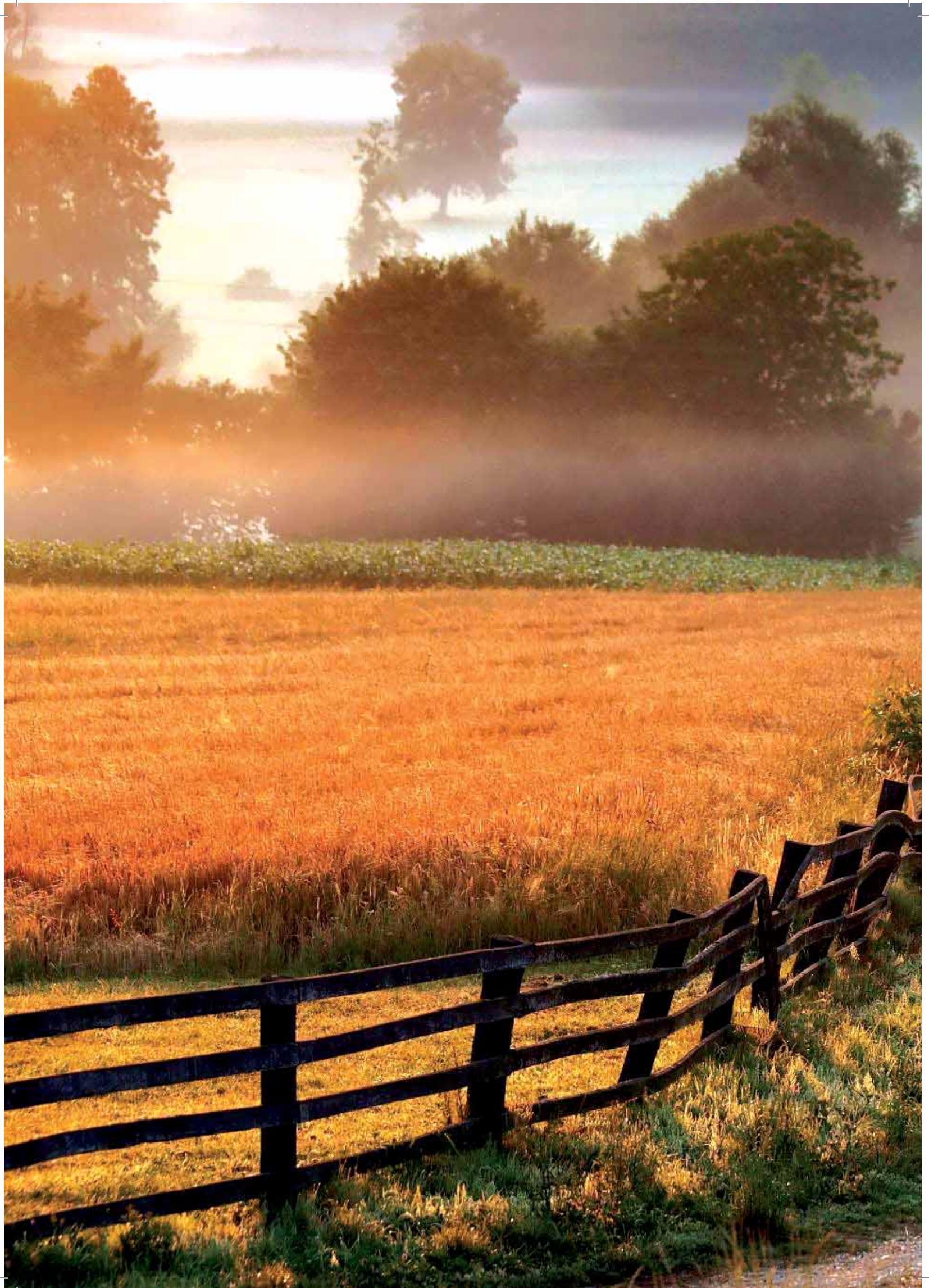

A scenic landscape featuring a dirt road that curves through a field of tall grass and wildflowers. On the left, a rustic wooden fence runs along the edge of the field. In the background, several large trees stand under a dramatic, cloudy sky. The overall atmosphere is misty and serene.

Trituradoras hidráulicas
para excavadoras

Hydraulic mulchers
for excavators

Broyeurs hydrauliques
pour minipelles

TFVLHC • TARIM



TRITURADORA LIGERA DE MARTILLOS O CUCHILLAS CON MOTOR HIDRÁULICO PARA MINIEXCAVADORA DE 1,5 A 3 TON. PARA TRONCOS HASTA Ø3CM

Trituradora TFVLHC de martillos o cuchillas con motor hidráulico para miniexcavadoras de 1,5 a 3 Tn. Para ramas de hasta 3 cm. Enganche para adaptación a miniexcavadoras.













LIGHT-WEIGHT MULCHER WITH SWINGING HAMMERS OR FLAILS AND WITH AN HYDRAULIC PUMP TO FIT MINI-EXCAVATOR FROM 1,5 TO 3 TON. FOR LOGS UP TO Ø3CM

T.F.V.L.H.C. mulcher with hammers or flails. Equipped with an hydraulic pump. Suitable for excavators from 1,5 to 3 Tn. For branches up to 3 cm. Attachment for mini excavators.

BROYEUR LEGÈRE À MARTEUX OSCILLANTS OU LAMES AVEC MOTEUR HYDRAULIQUE POUR L'ACCOUPLÉMENT SUR MINI-PELLES DU 1,5 A 3 TON. POUR TRONCS JUSQU'À Ø3CM

Broyeur TFVLHC avec marteaux ou lames. Équipé avec moteur hydraulique pour minipelles du 1,5 à 3 Tn. Pour branches jusqu'à 3 cm de diamètre. Pièces de fixation sur mini-pelles.



		Modelos Model Modèle			
		TFVLHC 60	TFVLHC 80	TFVLHC 100	TFVLHC 120
	Peso excav. Weight excav. Poids Pelle	1,5-3 TN	1,5-3 TN	1,5-3 TN	1,5-3 TN
	Ancho trabajo Working Width Largeur travail	600	800	1000	1200
	Medidas exteriores Outer dimensions Mesures extérieures	A cm. 48 B cm. 82 C cm. 58	48 102 58	48 122 58	48 144 58
	Ø mm. Rotor con martillos Ø mm. Rotor with hammers Ø mm. Rotor avec marteaux	300	370	370	370
	Ø cm. máx. tronco Ø cm. máx. trunc Ø cm. max. tronc	3	3	3	3
	Nº Martillos Num. Hammers Marteaux oscillants	8	10	12	14
	Nº Cuchilla Num. Blades Nbre. Lames	16	30	36	42
	Peso Weight Poids	120	152	180	208
	Caudal aceite Oil flow Débit d'huile	25-35	30-35	30-40	35-45
	Presión (BAR) Pressure (BAR) Pression (BAR)	180-200	150-180	150-180	150-180
	Protección delantera Front guard Protection frontal	Goma Rubber Gomme			
	Rodillo regulable altura Roller height adjust Rouleau réglable en hauteur	De serie Standard De serié			
	Patin protecc. chasis Skids chasis protec. Patins protec chasis	De serie Standard De serié			



PRECIO | PRICE | PRIX

TFVLHC 60	2.970,00€
TFVLHC 80	3.800,00€
TFVLHC 100	4.025,00€
TFVLHC 120	4.425,00€

Equipamiento de serie | Standard equipment | Équipement standard

· Latiguillos incluidos | Hoses included | **Fléxibles inclus**

Opciones | Options | Options

Enganche adaptación a miniexcavadora |

Attachment for mini-excavator |

Accouplement pour mini-pelles et mini-excavateurs

340,00€

Enganche adaptación minicargadora |

Attachment miniloader |

Accouplement minichargeuses

580,00€



TFVLIHML • KRISHNA



TRITURADORA LIGERA DE MARTILLOS O CUCHILLAS CON MOTOR HIDRÁULICO TRANSMISIÓN POR CORREAS AL EJE PARA MINIEXCAVADORA DE 2 A 5 TON. PARA TRONCOS DE Ø5

Trituradoras de martillos o cuchillas con motor hidráulico y transmisión por correas al eje Para miniexcavadoras de 2 a 5 Tn. Para ramas de hasta 5cm de diámetro. Enganche para adaptación a miniexcavadoras.









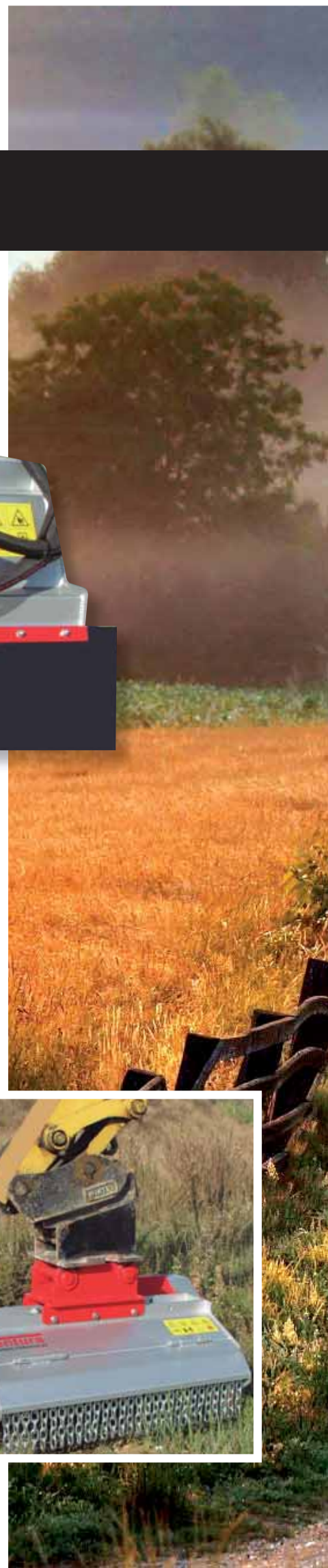



LIGHT-WEIGHT MULCHER WITH SWINGING HAMMERS OR FLAILS AND WITH AN HYDRAULIC PUMP AND BELT DRIVE FIT MINI-EXCAVATOR FROM 2 TO 5 TON. FOR LOGS FROM Ø5

Mulcher with hammers or flails. Equipped with an hydraulic pump and belt drive. Suitable for excavators from 2-5 Tn. For branches up to 5cm diameter. For branches from 5cm diameter. Attachment for mini excavators.

BROYEUR LEGÈRE À MARTEUX OSCILLANTS OU LAMESET MOTEUR HYDRAULIQUE AVEC COURROIES POUR L'ACCOUPLLEMENT SUR MINI-PELLES DU 2 A 5 TON. POUR TRONCS DU Ø5CM

Broyeur avec marteaux ou lames. Entraîné par moteur hydraulique et courroies pour mini-pelles du 2 à 5 Tn. Pour branches jusqu'à 5cm de diamètre. Pièces de fixation sur mini-pelles.



		Modelos	Model	Modèle
		TFVLIHML 80	TFVLIHML 120	
	Peso excav. Weight excav. Poids Pelle	2-5 TN	2-5 TN	
	Ancho trabajo Working Width Largeur travail	800	1200	
	Medidas exteriores Outer dimensions Mesures extérieures	A cm. B cm. C cm.	52 108 93	52 148 93
	Ø mm. Rotor con martillos Ø mm. Rotor with hammers Ø mm. Rotor avec marteaux	350	350	
	Ø cm. máx. tronco Ø cm. máx. trunc Ø cm. max. tronc	5	5	
	Nº Martillos Num. Hammers Marteaux oscillants	14	18	
	Peso Weight Poids	268	300	
	Nº Correas Num. Belts Num. Courroies	3B	3B	
	Caudal aceite Oil flow Débit d'huile	40-60	65-85	
	Presión (BAR) Pressure (BAR) Pression (BAR)	180-200	180-200	
	Protección delantera Front guard Protection frontal	Metálico Metal Métallique		
	Patín protecc. chasis Skids chasis protec. Patins protec chasis	De serie Standard De sérié		



PRECIO | PRICE | PRIX

TFVLIHML 80	3.155,00€
TFVLIHML 120	3.525,00€

Equipamiento de serie | Standard equipment | Équipement standard

· Latiguillos incluidos | Hoses included | **Fléxibles inclus**

Opciones | Options | Options

Enganche adaptación a miniexcavadora |
Attachment for mini-excavator |

Accouplement pour mini-pelles et mini-excavateurs

520,00€



TFVLIHM • CABRIEL



TRITURADORA LIGERA DE MARTILLOS O CUCHILLAS CON MOTOR HIDRÁULICO TRANSMISIÓN POR CORREAS AL EJE PARA MINIEXCAVADORA DE 4 A 8 TON. PARA TRONCOS DE Ø6CM

TFVLIHM Trituradoras de martillos o cuchillas con motor hidráulico y transmisión por correas al eje Para miniexcavadoras de 4 a 8 Tn. Para ramas de hasta 6 cm de diámetro. Enganche para adaptación a miniexcavadoras.















LIGHT-WEIGHT MULCHER WITH SWINGING HAMMERS OR FLAILS AND WITH AN HYDRAULIC PUMP AND BELT DRIVE FIT MINI-EXCAVATOR FROM 4 TO 8 TON. FOR LOGS FROM Ø6CM

T.F.V.L.I.H.M. mulcher with hammers or flails. Equipped with an hydraulic pump and belt drive. Suitable for excavators from 4-8 Tn. For branches up to 6 cm diameter. For branches from 5-6 cm diameter. Attachment for mini excavators.

BROYEUR LEGÈRE À MARTEUX OSCILLANTS OU LAMES ET MOTEUR HYDRAULIQUE AVEC COURROIES POUR L'ACCOUPLLEMENT SUR MINI-PELLES DU 4 A 8 TON. POUR TRONCS DU Ø6CM

Broyeur TFVLIHM avec marteaux ou lames. Entraîné par moteur hydraulique et courroies pour mini-pelles du 4 à 8 Tn. Pour branches jusqu'à 6 cm de diamètre. Pièces de fixation sur mini-pelles.



		Modelos		Model		Modèle	
		TFVLIHM 80	TFVLIHM 100	TFVLIHM 120	TFVLIHM 140	TFVLIHM 160	
	Peso excav. Weight excav. Poids Pelle	4-8 TN	4-8 TN	4-8 TN	4-8 TN	4-8 TN	
	Ancho trabajo Working Width Largeur travail	800	1000	1200	1400	1600	
	Medidas exteriores Outer dimensions Mesures extérieures	A cm. 52 B cm. 108 C cm. 93	52 128 93	52 148 93	52 168 93	52 188 93	
	Ø mm. Rotor con martillos Ø mm. Rotor with hammers Ø mm. Rotor avec marteaux	430	430	430	430	430	
	Ø cm. máx. tronco Ø cm. máx. trunc Ø cm. max. tronc	6	6	6	6	6	
	Nº Martillos Num. Hammers Marteaux oscillants	12	14	18	22	24	
	Nº Cuchilla Num. Blades Nbre. Lames	48	56	72	88	96	
	Peso Weight Poids	310	350	405	455	498	
	Nº Correas Num. Belts Num. Courroies	3B	3B	3B	3B	3B	
	Caudal aceite Oil flow Débit d'huile	45-55	60-65	60-65	70-80	70-80	
	Presión (BAR) Pressure (BAR) Pression (BAR)	180-200	180-200	180-200	180-200	180-200	
	Protección delantera Front guard Protection frontal	Goma Rubber Gomme					
	Rodillo regulable altura Roller height adjust Rouleau réglable en hauteur	De serie Standard De série					
	Patín protecc. chasis Skids chasis protec. Patins protec chasis	De serie Standard De série					



PRECIO | PRICE | PRIX

TFVLIHM 80	5.725,00€
TFVLIHM 100	5.975,00€
TFVLIHM 120	6.275,00€
TFVLIHM 140	6.475,00€
TFVLIHM 160	6.725,00€

Equipamiento de serie | Standard equipment | Équipement standard

· Latiguillos incluidos | Hoses included | **Fléxibles inclus**

Opciones | Options | Options

Enganche adaptación a miniexcavadora |
Attachment for mini-excavator |

Accouplement pour mini-pelles et mini-excavateurs

520,00€



TFVLMFH • TOCATINS



TFVLMFH - TRITURADORAS HIDRÁULICAS LIGERAS PARA EXCAVADORA DE 5 A 10 TN.

TFVLMFH Trituradoras de martillos fijos de widia con motor hidráulico y transmisión por correas al eje Para miniexcavadoras de 5 a 10 Tn. Para ramas de hasta 12cm de diámetro. Enganche para adaptación a miniexcavadoras y minicargadoras.















TFVLMFH - LIGHTWEIGHT HYDRAULIC MULCHERS TO FIT MINI EXCAVATORS FROM 5 TO 10 TN

TFVLMFH mulcher with fixed widia hammers equipped with an hydraulic pump and belt drive. Suitable for excavators from 5-12 tn. For branches up to 10 cm diameter. Attachment for mini excavators and mini loader.

TFVLMFH - BROYEURS HYDRAULIQUES LÉGERS POUR MINIPELLES DU 5 À 10 TN.

Broyeur TFVLMFH avec fixe widia marteaux. Entraîné par moteur hydraulique et courroies pour mini-pelles du 5 à 12 Tn. Pour branches jusqu'à 10 cm de diamètre. Pièces de fixation sur mini-pelles et mini-chargeuse.



		Modelos Model Modèle				
		TFVLMFH 80	TFVLMFH 100	TFVLMFH 120	TFVLMFH 140	TFVLMFH 160
	Peso excav. Weight excav. Poids Pelle	5-10 TN	5-10 TN	5-10 TN	5-10 TN	5-10 TN
	Ancho trabajo Working Width Largeur travail	800	1000	1200	1400	1600
	Medidas exteriores Outer dimensions Mesures extérieures	A cm. B cm. C cm.	52 108 93	52 128 93	52 148 93	52 168 93
	Ø mm. Rotor con martillos Ø mm. Rotor with hammers Ø mm. Rotor avec marteaux	450	450	450	450	450
	Ø cm. máx. tronco Ø cm. máx. trunc Ø cm. max. tronc	12	12	12	12	12
	Martillos fijos Vidia Fixed Widia Hammers Marteaux fixes Vidia	18	20	24	28	30
	Peso Weight Poids	480	545	595	620	640
	Nº Correas Num. Belts Num. Courroies	4B	4B	4B	4B	4B
	Caudal aceite Oil flow Débit d'huile	45-85	60-95	60-95	70-100	70-100
	Presión (BAR) Pressure (BAR) Pression (BAR)	180-200	180-200	180-200	180-200	180-200
	Protección delantera Front guard Protection frontal	Cadena Chain Chaîne				
	Protección trasera Back guard Protection arrière	Goma Rubber Gomme				
	Rodillo regulable altura Roller height adjust Rouleau réglable en hauteur	De serie Standard De serié				
	Patín protecc. chasis Skids chasis protec. Patins protec chasis	De serie Standard De serié				



PRECIO | PRICE | PRIX

TFVLMFH 80	10.690,00€
TFVLMFH 100	11.300,00€
TFVLMFH 120	12.560,00€
TFVLMFH 140	13.540,00€
TFVLMFH 160	14.360,00€

Equipamiento de serie | Standard equipment | Équipement standard

- Válvula anticavitación y latiguillos incluidos en el precio
Anti-cavitation valve and hoses included in the price
Anti-cavitation vannes et tuyaux inclus dans le prix

Opciones | Options | Options

- Enganche adaptación a miniexcavadora | Attachment for mini-excavator
Accouplement pour mini-pelles et mini-excavateurs

520,00€



TFVNMFH • MEKONG

















Trituradora hidráulica forestal con martillo fijo para miniexcavadoras de 5 a 12 tn. Equipado con bomba hidráulica y transmisión por correa y puerta hidráulica. Para ramas de hasta 12 cm de diámetro. Trituradora para miniexcavadoras y minicargadoras.

Hydraulic forestry mulcher with fixed hammer to fit mini excavators form 5 to 12 tn. Equipped with an hydraulic pump and belt drive and hydraulic door. For branches up to 12 cm diameter. Attachment for mini excavators and mini loader.

Broyeur hydraulique forestier à marteau fixe pour mini-pelles de 5 à 12 tonnes. Équipé d'une pompe hydraulique et d'un entraînement par courroie et d'une porte hydraulique. Pour les branches jusqu'à 12 cm de diamètre. Concasseur pour mini pelles et mini chargeurs.



		Modelos Model Modèle				
		TFVNMFH 80	TFVNMFH 100	TFVNMFH 120	TFVNMFH 140	TFVNMFH 160
	Peso excav. Weight excav. Poids Pelle	5-12 TN	5-12 TN	5-12 TN	5-12TN	5-12 TN
	Ancho trabajo Working Width Largeur travail	800	1000	1200	1400	1600
	Medidas exteriores Outer dimensions Mesures extérieures	A cm. 52 B cm. 108 C cm. 93	52 128 93	52 148 93	52 168 93	52 188 93
	Ø mm. Rotor con martillos Ø mm. Rotor with hammers Ø mm. Rotor avec marteaux	450	450	450	450	450
	Ø cm. máx. tronco Ø cm. máx. trunc Ø cm. max. tronc	12	12	12	12	12
	Martillos fijos Vidia Fixed Vidia Hammers Marteaux fixes Vidia	18	20	24	28	30
	Peso Weight Poids	495	560	610	635	655
	Nº Correas Num. Belts Num. Courroies	4B	4B	4B	4B	4B
	Caudal aceite Oil flow Débit d'huile	45-85	60-95	60-95	70-100	70-100
	Presión (BAR) Pressure (BAR) Pression (BAR)	180-200	180-200	180-200	180-200	180-200
	Protección delantera Front guard Protection frontal	Cadena Chain Chaîne				
	Protección trasera Back guard Protection arrière	Goma Rubber Gomme				
	Rodillo regulable altura Roller height adjust Rouleau réglable en hauteur	De serie Standard De sérié				
	Patín protecc. chasis Skids chasis protec. Patins protec chasis	De serie Standard De sérié				



PRECIO | PRICE | PRIX

TFVNMFH 80	11.224,00€
TFVNMFH 100	11.865,00€
TFVNMFH 120	13.180,00€
TFVNMFH 140	14.215,00€
TFVNMFH 160	15.080,00€

Equipamiento de serie | Standard equipment | Équipement standard

- Válvula anticavitación y latiguillos incluidos en el precio
Anti-cavitation valve and hoses included in the price
Anti-cavitation vannes et tuyaux inclus dans le prix

Opciones | Options | Options

- Enganche adaptación a miniexcavadora | Attachment for mini-excavator
Accouplement pour mini-pelles et mini-excavateurs 520,00€
- Electro válvula doble bobina accionamiento puerta hidráulica | Electro valve double coil hydraulic door drive | **Entraînement de porte hydraulique à double bobine d'électrovanne** 530,00€



TFVJAH • LACHLAN

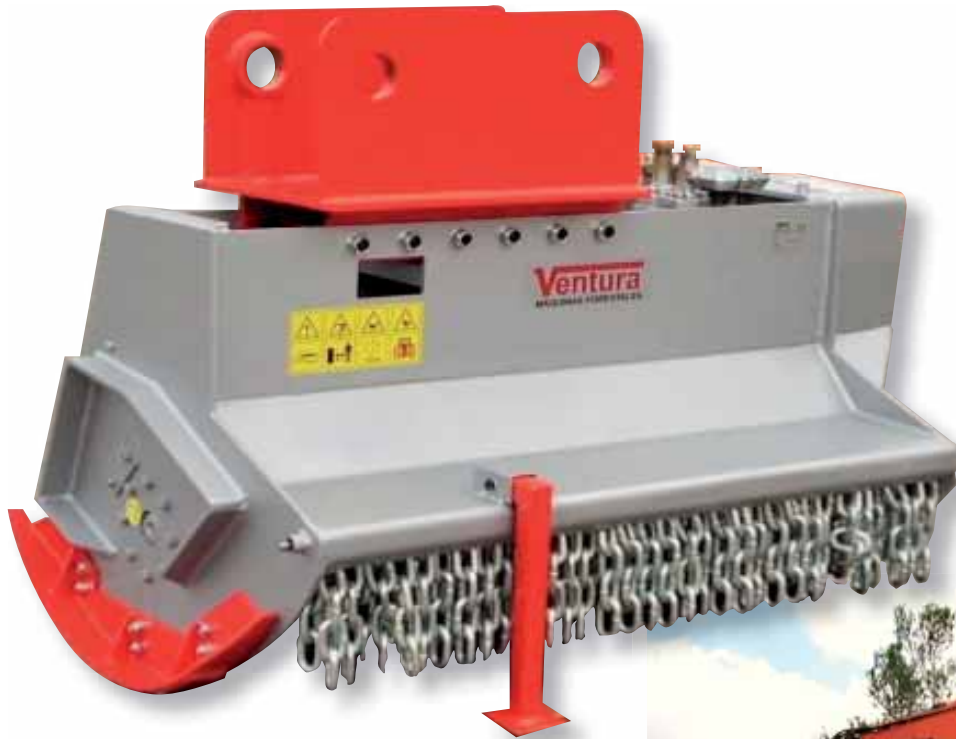







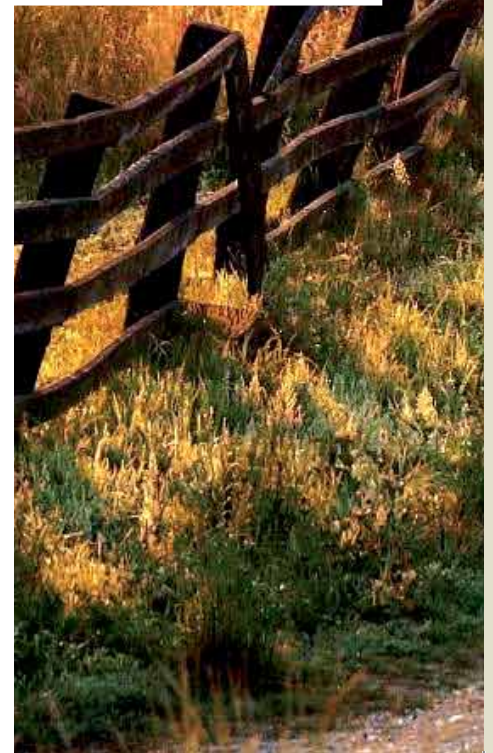





TRITURADORA FORESTAL DE MARTILLOS MÓVILES EQUIPADA CON MOTOR HIDRÁULICO DE PISTONES PREPARADA PARA ADAPTAR A EXCAVADORAS Y MINICARGADORAS DE 7 a 16 TON. PARA TRONCOS HASTA \varnothing 14cm

FORESTRY MULCHER WITH SWINGING HAMMERS EQUIPPED WITH HYDRAULIC PUMP OF PISTONS READY TO BE ATTACHED TO A EXCAVATOR OR MINILOADER FROM 7 to 16 TON. FOR LOGS UP TO \varnothing 14cm

BROYEUR FORESTIER MARTEUX OSCILLANTS EQUIPÉ AVEC UN MOTEUR HYDRAULIQUE À PISTON POUR L'ACCOUPLÉMENT SUR PELLE ET MINI CHARGEUSES DU 7 a 16 TON. POUR TRONCS JUSQU'À \varnothing 14cm



	Modelos		Model	Modèle		
	TFVJAH 100	TFVJAH 130	TFVJAH 150	TFVJAH 180	TFVJAH 200	TFVJAH 225
	7-16	7-16	7-16	7-16	7-16	7-16
	120	150	175	200	225	250
	435	435	435	435	435	435
	9	9	9	9	9	9
	13	15	17	19	21	23
	750	804	858	914	968	1024
	5	5	5	5	5	5
	80-120	80-120	80-120	80-120	80-120	80-120
	200-260	200-260	200-260	200-260	200-260	200-260
	Cadena doble Double chain Chaîne double					
	Opcional Option En option					
	De serie Standard De série					



PRECIO | PRICE | PRIX

TFVJAH 100	9.600,00€
TFVJAH 130	9.780,00€
TFVJAH 150	13.760,00€
TFVJAH 180	13.890,00€
TFVJAH 200	14.870,00€
TFVJAH 225	15.250,00€

Equipamiento de serie | Standard equipment | Équipement standard

- Chapa antidesgaste rotor | Rotor with wear resistant steel | **Rotor en acier anti-usure**
- Motor hidráulico de pistones | Hydraulic piston engine | **Moteur hydraulique à pistons**

Opciones | Options | Options

- Enganche para excavadora | Connection for excavators | **Accouplement pour excavateurs/pelles** 730,00€
- Puerta trasera hidráulica | Hydraulic rear door | **Capot arrière à ouverture hydraulique** 470,00€
- Electro válvula doble bobina accionamiento puerta hidráulica | Electro valve double coil hydraulic door drive | **Entraînement de porte hydraulique à double bobine d'électrovanne** 530,00€
- Latiguillos no incluidos | Hoses not included | **Flexibles non inclus**



TFVJH • NAVIA















TRITURADORA FORESTAL DE MARTILLOS MÓVILES 360° EQUIPADA CON MOTOR HIDRÁULICO DE PISTONES PREPARADA PARA ADAPTAR A EXCAVADORAS Y MINICARGADORAS DE 10 A 20 TON. PARA TRONCOS DE HASTA Ø20CM

FORESTRY MULCHER WITH 360° SWINGING HAMMERS EQUIPPED WITH HYDRAULIC OF PISTONS PUMP READY TO BE ATTACHED TO A EXCAVATOR OR MINILOADER FROM 10 TO 20 TON. FOR LOGS UP TO Ø20CM

BROYEUR FORESTIER À MARTEUX OSCILLANTS 360° EQUIPÉ AVEC UN MOTEUR HYDRAULIQUE DE PISTONS POUR L'ACCOUPLÉMENT SUR PELLERES ET MINI-CHARGEUSES DU 10 A 20 TON. POUR TRONCS JUSQU'À Ø20CM



	Modelos		Model	Modèle		
	TFVJH 100	TFVJH 130	TFVJH 150	TFVJH 180	TFVJH 200	TFVJH 225
	10-20 TN	10-20 TN	10-20 TN	10-20 TN	10-20 TN	10-20 TN
	1000	1300	1500	1800	2000	2250
	88 128 101	88 158 178	88 178 191	88 208 101	88 228 101	88 248 101
	455	455	455	455	455	455
	20	20	20	20	20	20
	16	20	24	28	32	36
	892	994	1094	1196	1298	1400
	5	5	5	7	7	7
	80-120	80-120	80-120	80-120	80-120	80-120
	200-260	200-260	200-260	200-260	200-260	200-260
	Cadena doble Double chain Chaîne double					
	De serie Standard De série					

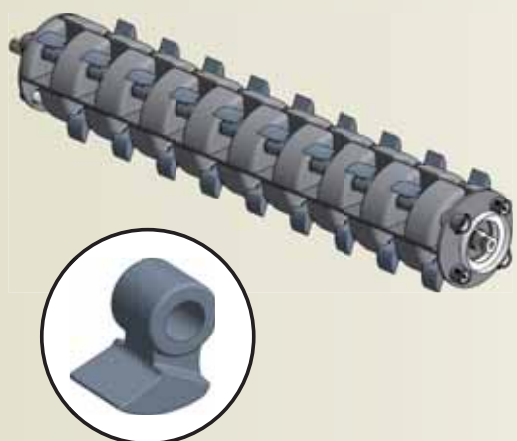

PRECIO | PRICE | PRIX

		Martillos de widia Widia hammers Marteaux en widia
TFVJH 100	13.820,00€	14.850,00€
TFVJH 130	14.370,00€	15.650,00€
TFVJH 150	14.920,00€	16.450,00€
TFVJH 180	15.370,00€	17.170,00€
TFVJH 200	15.860,00€	17.930,00€
TFVJH 225	16.820,00€	19.140,00€

Equipamiento de serie | Standard equipment | Équipement standard

- Chapa antidesgaste rotor | Rotor with wear resistant steel | **Rotor en acier anti-usure**
- Motor hidráulico de pistones | Hydraulic piston engine | **Moteur hydraulique à pistons**

Opciones | Options | Options

- Enganche para excavadora | Connection for excavators | **Accouplement pour excavateurs/pelles** 730,00€
- Puerta trasera hidráulica | Hydraulic rear door | **Capot arrière à ouverture hydraulique** 470,00€
- Electro válvula doble bobina accionamiento puerta hidráulica | Electro valve double coil hydraulic door drive | **Entraînement de porte hydraulique à double bobine d'électrovanne** 530,00€















TFVJMFH • COLUMBIA



TRITURADORA FORESTAL DE MARTILLOS FIJOS CON PUNTA DE WIDIA EQUIPADA CON MOTOR HIDRÁULICO DE PISTONES PREPARADA PARA ADAPTAR A EXCAVADORAS Y MINICARGADORAS DE 10 A 20 TON. PARA TRONCOS DE HASTA Ø20CM

FORESTRY MULCHER WITH FIXED WIDIA HAMMERS EQUIPPED WITH HYDRAULIC OF PISTONS PUMP READY TO BE ATTACHED TO A EXCAVATOR OR MINILOADER FROM 10 TO 20 TON. FOR LOGS UP TO Ø20CM

BROYEUR FORESTIER À MARTEUX FIXES EN WIDIA EQUIPÉ AVEC UN MOTEUR HYDRAULIQUE DE PISTONS POUR L'ACCOUPLLEMENT SUR PELLES ET MINI CHARGEUSES DU 10 A 20 TON. POUR TRONCS JUSQU'À Ø20CM

	Modelos		Model	Modèle		
	TFVJMFH 100	TFVJMFH 130	TFVJMFH 150	TFVJMFH 180	TFVJMFH 200	TFVJMFH 225
	10-20 TN	10-20 TN	10-20 TN	10-20 TN	10-20 TN	10-20 TN
	1000	1300	1500	1800	2000	2250
	88 128 101	88 158 178	88 178 191	88 208 101	88 228 101	88 248 101
	7	7	7	7	7	7
	460	460	460	460	460	460
	20	20	20	20	20	20
	16+2	20+2	24+2	28+2	32+2	34+2
	720	820	932	1034	1136	1238
	5	5	7	7	7	7
	80-120	80-120	80-120	80-120	80-120	80-120
	200-260	200-260	200-260	200-260	200-260	200-260
	Cadena doble Double chain Chaîne double					
	De serie Standard De série					



PRECIO | PRICE | PRIX

TFVJMFH 100	14.000,00€
TFVJMFH 130	15.785,00€
TFVJMFH 150	16.950,00€
TFVJMFH 180	18.720,00€
TFVJMFH 200	19.875,00€
TFVJMFH 225	20.365,00€

Equipamiento de serie | Standard equipment | Équipement standard

· Motor hidráulico de pistones | Hydraulic piston engine | **Moteur hydraulique à pistons**

Opciones | Options | Options

Enganche para excavadora | Connection for excavators |

Accouplement pour excavateurs/pelles 730,00€

Puerta trasera hidráulica | Hydraulic rear door | **Capot arrière à ouverture hydraulique** 470,00€

Electro válvula doble bobina accionamiento puerta hidráulica | Electro valve double coil hydraulic door drive | **Entraînement de porte hydraulique à double bobine d'électrovanne** 530,00€

Latiguillos no incluidos | Hoses not included | **Fléxibles non inclus**



TFVH • DON

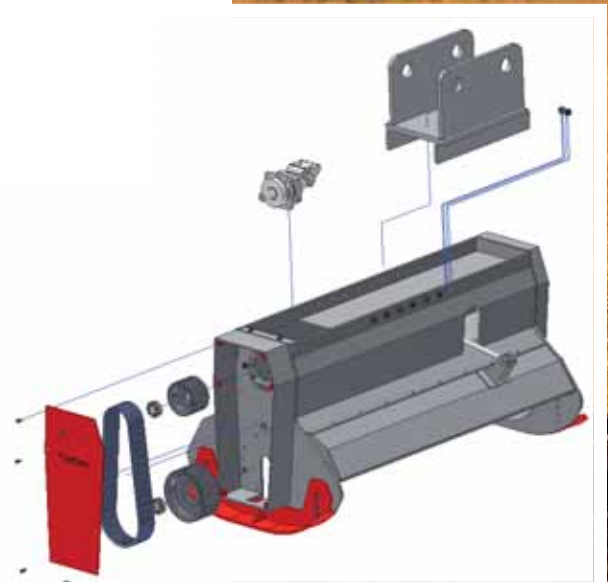











TRITURADORA FORESTAL DE MARTILLOS MÓVILES 360° EQUIPADA CON MOTOR HIDRÁULICO DE PISTONES PREPARADA PARA ADAPTAR EXCAVADORAS DE DE 16 A 30 TON. PARA TRONCOS DE HASTA Ø30CM

FORESTRY MULCHER WITH 360° SWINGING HAMMERS EQUIPPED WITH HYDRAULIC ENGINE OF PISTONS READY TO BE ATTACHED TO AN EXCAVATOR FROM 16 TO 30 TON. FOR LOGS UP TO Ø30CM

BROYEUR FORESTIER À MARTEUX OSCILLANTS 360° EQUIPÉ AVEC UN MOTEUR À PISTON HYDRAULIQUE POUR L'ACCOUPLÉMENT SUR PELLES DU 16 A 30 TON. POUR TRONCS JUSQU'À Ø30CM



		Modelos		Model	Modèle	
		TFVH 120	TFVH 140	TFVH 160	TFVH 180	TFVH 200
	Peso excav. Weight excav. Poids Pelle	16-30 TN	16-30 TN	16-30 TN	16-30 TN	16-30 TN
	Ø mm. Rotor con martillos Ø mm. Rotor with hammers Ø mm. Rotor avec marteaux	635	635	635	635	635
	Ø cm. máx. tronco Ø cm. máx. trunc Ø cm. max. tronc	30	30	30	30	30
	Martillos móviles Swinging Hammers Marteaux oscillants	16	20	24	28	32
	Peso Weight Poids	1430	1520	1615	1710	1800
	Nº Correas Num. Belts Num. Courroies	6	6	6	6	6
	Caudal aceite Oil flow Débit d'huile	145	155	165	175	205
	Presión (BAR) Pressure (BAR) Pression (BAR)	200-260	200-260	200-260	200-260	200-260
	Protección delantera Front guard Protection frontal	Cadena doble Double chain Chaîne double				
	Patin protecc. chasis Skids chasis protec. Patins protec chasis	De serie Standard De série				



PRECIO | PRICE | PRIX

		Martillos de widia Widia hammers Marteaux en widia
TFVH 120	18.680,00€	19.550,00€
TFVH 140	19.230,00€	20.320,00€
TFVH 160	19.980,00€	21.300,00€
TFVH 180	20.850,00€	22.380,00€
TFVH 200	21.610,00€	23.370,00€

Equipamiento de serie | Standard equipment | Équipement standard

- Chapa antidesgaste rotor | Rotor with wear resistant steel | **Rotor en acier anti-usure**
- Motor hidráulico de pistones | Hydraulic piston engine | **Moteur hydraulique à pistons**

Opciones | Options | Options

Enganche para excavadora Connection for excavators Accouplement pour excavateurs/pelles	850,00€
Puerta trasera hidráulica Hydraulic rear door Capot arrière à ouverture hydraulique	470,00€
Electro válvula doble bobina accionamiento puerta hidráulica Electro valve double coil hydraulic door drive Entraînement de porte hydraulique à double bobine d'électrovanne	530,00€
Latiguillos no incluidos Hoses not included Fléxibles non inclus	



TFVMFH • TIGRE

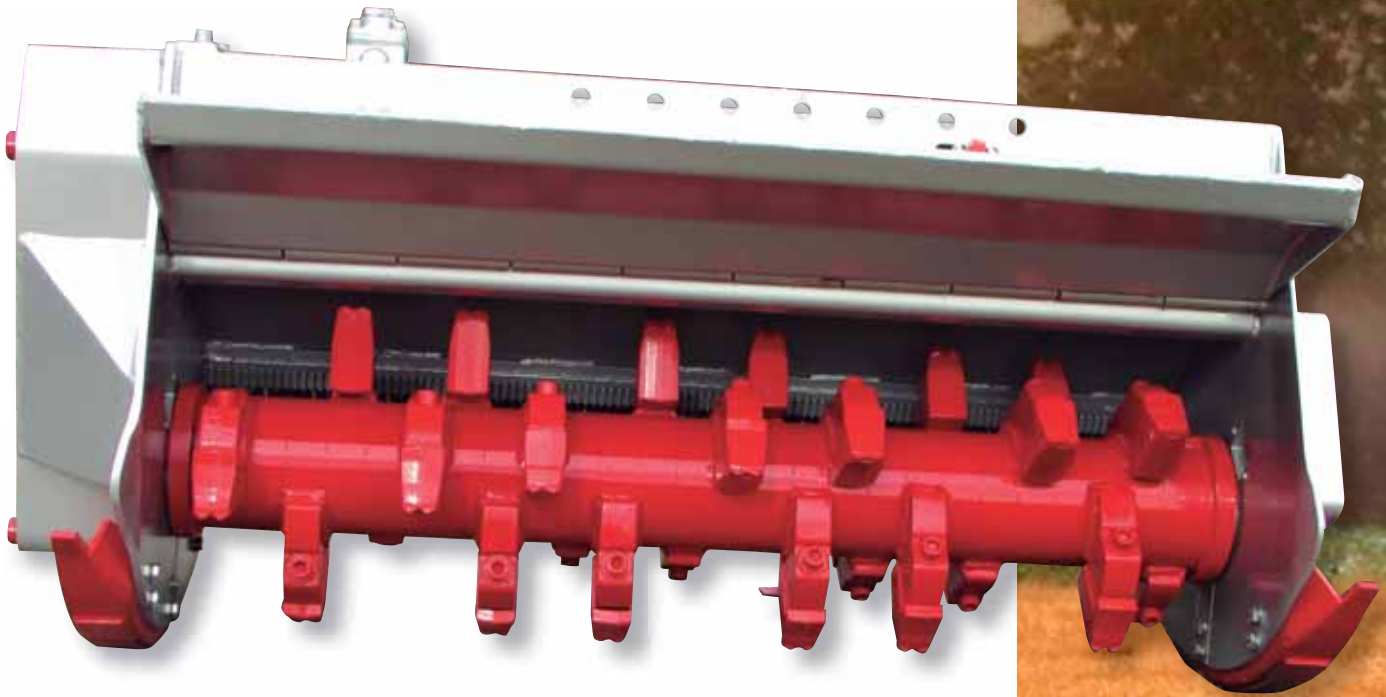







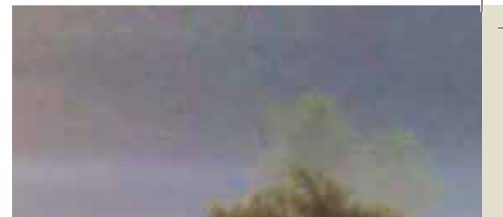





TRITURADORA FORESTAL DE MARTILLOS FIJOS CON PUNTA DE WIDIA EQUIPADA CON MOTOR HIDRÁULICO DE PISTONES PREPARADA PARA ADAPTAR EXCAVADORAS DE 16 A 30 TON. PARA TRONCOS HASTA Ø30CM

FORESTRY MULCHER WITH FIXED WIDIA HAMMERS EQUIPPED WITH HYDRAULIC PUMP OF PISTONS READY TO BE ATTACHED TO A EXCAVATOR FROM 16 TO 30 TON. FOR LOGS UP TO Ø30CM

BROYEUR FORESTIER À MARTEUX FIXES EN WIDIA EQUIPÉ AVEC UN MOTEUR À PISTON HYDRAULIQUE POUR L'ACCOUPLLEMENT SUR PELLES DU 16 A 30 TON. POUR TRONCS JUSQU'À Ø30CM



		Modelos		Model		Modèle	
		TFVMFH 120	TFVMFH 140	TFVMFH 160	TFVMFH 180	TFVMFH 200	
	Peso excav. Weight excav. Poids Pelle	16-30 TN	16-30 TN	16-30 TN	16-30 TN	16-30 TN	
	Ancho trabajo Working Width Largeur travail	1200	1400	1600	1800	2000	
	Medidas exteriores Outer dimensions Mesures extérieures	A cm. 110 B cm. 153 C cm. 112	110 173 112	110 193 112	110 213 112	110 233 112	
	Profundidad cm Depth cm Profondeur cm	9	9	9	9	9	
	∅ mm. Rotor con martillos ∅ mm. Rotor with hammers ∅ mm. Rotor avec marteaux	585	585	585	585	585	
	∅ cm. máx. tronco ∅ cm. máx. trunc ∅ cm. max. tronc	30	30	30	30	30	
	Martillos fijos Vidia Fixed Vidia Hammers Marteaux fixes Vidia	16+2	20+2	24+2	28+2	32+2	
	Peso Weight Poids	1572	1602	1705	1805	1900	
	Nº Correas Num. Belts Num. Courroies	6	6	6	6	6	
	Caudal aceite Oil flow Débit d'huile	155	155	165	175	205	
	Presión (BAR) Pressure (BAR) Pression (BAR)	200-260	200-260	200-260	200-260	200-260	
	Protección delantera Front guard Protection frontal	Cadena doble Double chain Chaîne double					
	Patín protecc. chasis Skids chasis protec. Patins protec chasis	De serie Standard De série					



PRECIO | PRICE | PRIX

TFVMFH 120	21.600,00€
TFVMFH 140	22.150,00€
TFVMFH 160	23.050,00€
TFVMFH 180	23.450,00€
TFVMFH 200	25.850,00€

Equipamiento de serie | Standard equipment | Équipement standard

· Motor hidráulico de pistones | Hydraulic piston engine | Moteur hydraulique à pistons

Opciones | Options | Options

Eenganche para excavadora | Connection for excavators

Accouplement pour excavateurs/pelles 850,00€

Puerta trasera hidráulica | Hydraulic rear door |

Capot arrière à ouverture hydraulique 470,00€

Electro válvula doble bobina accionamiento puerta hidráulica | Electro valve double coil

hydraulic door drive | Entraînement de porte hydraulique à double bobine d'électrovanne 530,00€

Latiguillos no incluidos | Hoses not included | Flexibles non inclus

TFMFH • AWASH

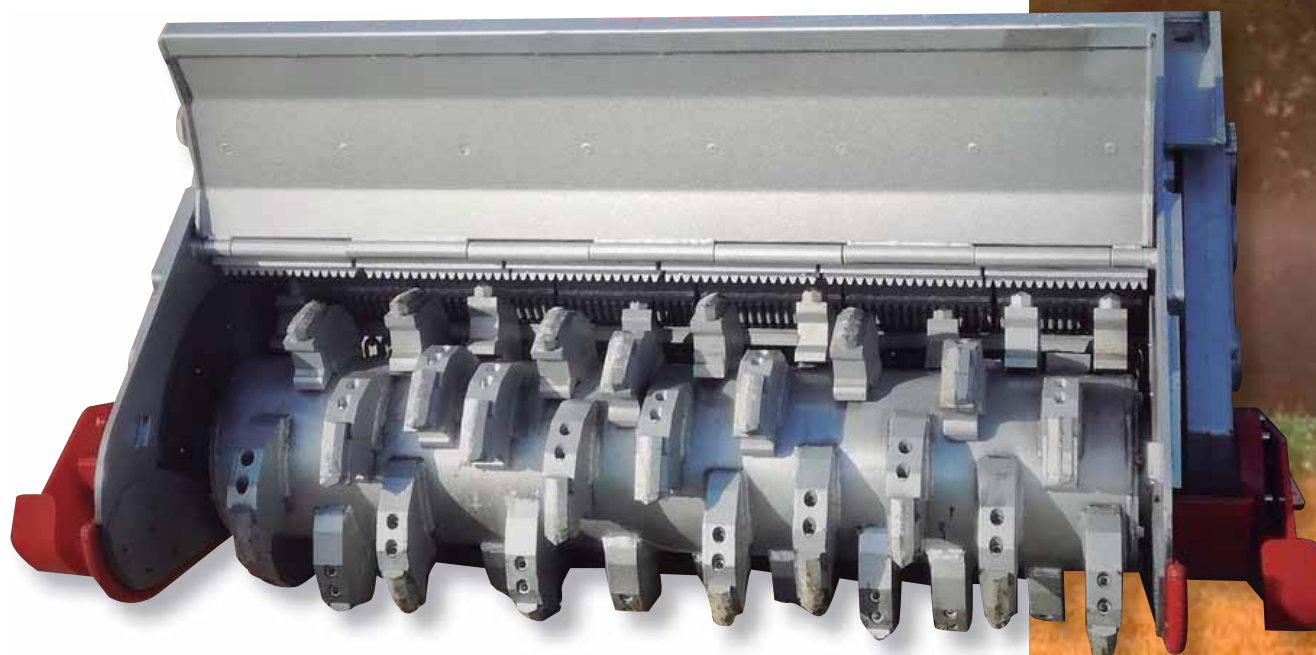













TRITURADORA FORESTAL DE MARTILLOS FIJOS CON PUNTA DE WIDIA EQUIPADA CON MOTOR HIDRÁULICO DE PISTONES PREPARADA PARA ADAPTAR EXCAVADORAS DE 25 A 40 TON. PARA TRONCOS HASTA Ø40CM

FORESTRY MULCHER WITH FIXED WIDIA HAMMERS EQUIPPED WITH HYDRAULIC PUMP OF PISTONS READY TO BE ATTACHED TO A EXCAVATOR FROM 25 TO 40 TON. FOR LOGS UP TO Ø40CM

BROYEUR FORESTIER À MARTEUX FIXES EN WIDIA ÉQUIPÉ AVEC UN MOTEUR À PISTON HYDRAULIQUE POUR L'ACCOUPLLEMENT SUR PELLES DU 25 A 40 TON. POUR TRONCS JUSQU'À Ø40CM



		Modelos	Model	Modèle
		TFMFH 120	TFMFH 140	TFMFH 160
	Peso excav. Weight excav. Poids Pelle	25-40	25-40	25-40
	Ancho trabajo Working Width Largeur travail	1200	1400	1600
	Medidas exteriores Outer dimensions Mesures extérieures	A cm. 124 B cm. 162 C cm. 116	124 182 116	124 202 116
	Profundidad cm Depth cm Profondeur cm	15	15	15
	Ø mm. Rotor con martillos Ø mm. Rotor with hammers Ø mm. Rotor avec marteaux	675	675	675
	Ø cm. máx. tronco Ø cm. máx. trunc Ø cm. max. tronc	40	40	40
	Martillos fijos Vidia Fixed Vidia Hammers Marteaux fixes Vidia	20+2	28+2	36+2
	Peso Weight Poids	2410	2530	2650
	Nº Correas Num. Belts Num. Courroies	6C	6C	6C
	Caudal aceite Oil flow Débit d'huile	190-340	190-340	190-340
	Presión (BAR) Pressure (BAR) Pression (BAR)	200-350	200-350	200-350
	Protección delantera Front guard Protection frontal	Cadena doble Double chain Chaîne double		
	Patín protecc. chasis Skids chasis protec. Patins protec chasis	De serie Standard De série		



PRECIO | PRICE | PRIX

TFMFH 120	39.500,00€
TFMFH 140	41.400,00€
TFMFH 160	43.300,00€

Equipamiento de serie | Standard equipment | Équipement standard

- Motor hidráulico de pistones | Hydraulic piston engine | Moteur hydraulique à pistons
- Predisposición de colocar doble motor hidráulico | Predisposition to place double hydraulic motor | Prédiposition à placer un double moteur hydraulique

Opciones | Options | Options

Enganche para excavadora Connection for excavators Accouplement pour excavateurs/pelles	3.500,00€
2 motores de pistones en línea 2 in-line piston engines 2 moteurs à pistons en ligne	6.800,00€
Bloque hidráulico de seguridad sobrepresión Overpressure safety hydraulic block Bloc hydraulique de sécurité contre les surpressions	2.600,00€
Electro válvula doble bobina accionamiento puerta hidráulica Electro valve double coil hydraulic door drive Entraînement de porte hydraulique à double bobine d'électrovanne	530,00€



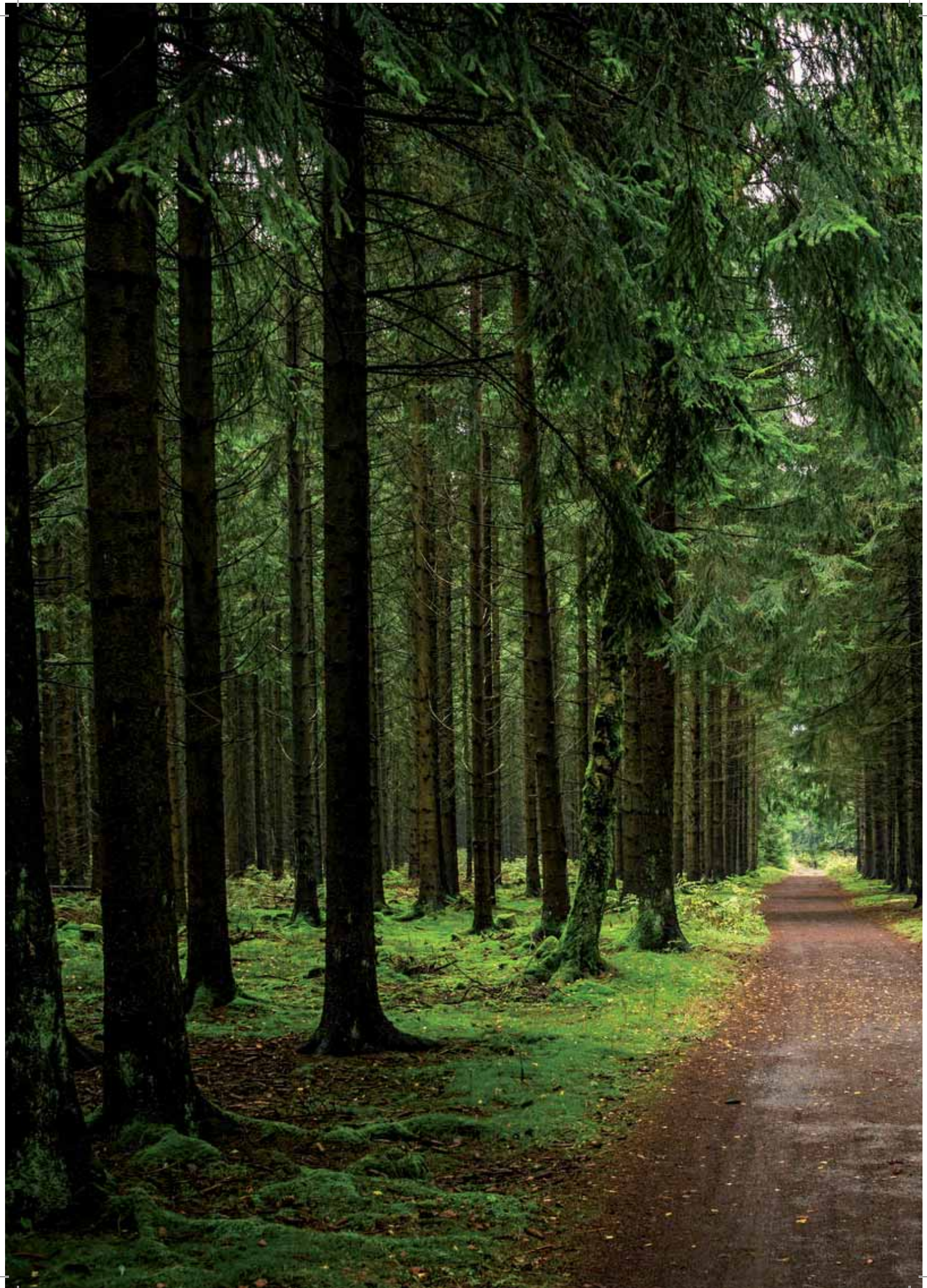

A photograph of a dense forest of tall, thin evergreen trees. The trees are dark green and have a conical shape. The ground is covered in a layer of green moss and fallen leaves. A dirt path is visible in the lower-left corner. The lighting is soft, suggesting an overcast day or a shaded forest.

Trituradoras hidráulicas
para mini y palas cargadoras

Hydraulic mulchers
for mini and loaders

Broyeurs hydrauliques
pour mini et chargeurs

TFVLIHMC • INDUS

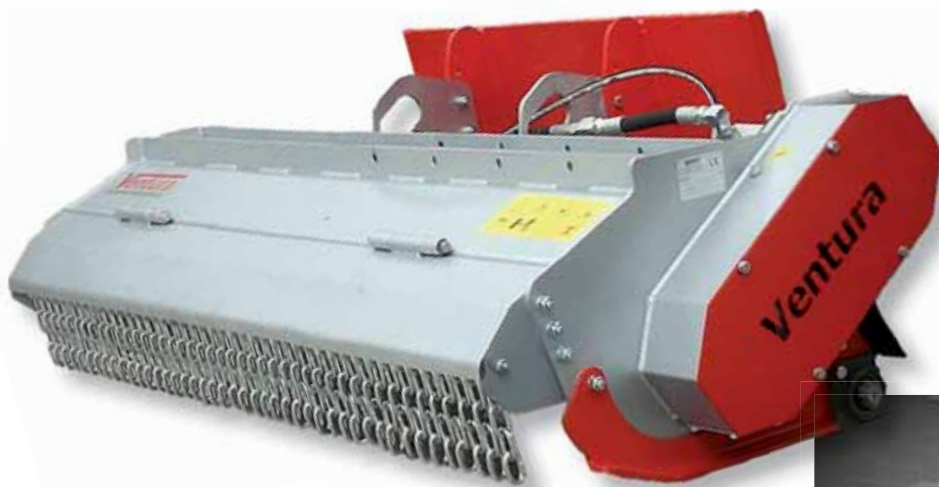













TRITURADORAS DE MARTILLOS O CUCHILLAS CON MOTOR HIDRÁULICO Y TRANSMISIÓN POR CORREAS AL EJE. PARA MINICARGADORA. PARA RAMAS DE HASTA 5-6 CM DE DIÁMETRO. ENGANCHE PARA ADAPTACIÓN A MINICARGADORA

MULCHER WITH HAMMERS OR FLAILS. EQUIPPED WITH AN HYDRAULIC PUMP AND BELT DRIVE. SUITABLE FOR SKID-STEER. FOR BRANCHES UP TO 5-6 CM DIAMETER. ATTACHMENT FOR SKID-STEER

BROYEUR DE MARTEAUX OU LAMES À MOTEUR HYDRAULIQUE ET TRANSMISSION PAR COURROIES À L'AXE. POUR MINI CHARGEUR. POUR LES BRANCHES JUSQU'À 5-6 CM DE DIAMÈTRE. CROCHET POUR L'ADAPTATION DU MINI CHARGEUR



		Modelos Model Modèle					
		TFVLIHMC 100	TFVLIHMC 120	TFVLIHMC 140	TFVLIHMC 160	TFVLIHMC 180	TFVLIHMC 200
	Ancho trabajo Working Width Largeur travail	1000	1200	1400	1600	1800	2000
	Medidas exteriores Outer dimensions Mesures extérieures	A cm. 52 B cm. 128 C cm. 93	52 148 93	52 168 93	52 188 93	52 208 93	52 228 93
	Ø mm. Rotor con martillos Ø mm. Rotor with hammers Ø mm. Rotor avec marteaux	430	430	430	430	430	430
	Ø cm. máx. tronco Ø cm. máx. trunc Ø cm. max. tronc	6	6	6	6	6	6
	Nº Martillos Num. Hammers Nbre. Lames	14	18	22	24	26	28
	Nº Cuchilla Num. Blades Nbre. Lames	28	36	44	48	52	56
	Peso Weight Poids	350	405	455	498	542	585
	Nº Correas Num. Belts Num. Courroies	3B	3B	3B	3B	3B	3B
	Caudal aceite Oil flow Débit d'huile	60-65	60-65	70-80	70-80	70-90	70-90
	Presión (BAR) Pressure (BAR) Pression (BAR)	180-200	180-200	180-200	180-200	180-200	180-200
	Protección delantera Front guard Protection frontal	Goma Rubber Gomme					
	Rodillo regulable altura Roller height adjust Rouleau réglable en hauteur	De serie Standard De sérié					
	Patín protec. chasis Skids chasis protec. Patins protec chasis	De serie Standard De sérié					



PRECIO | PRICE | PRIX

TFVLIHMC 100	6.560,00€
TFVLIHMC 120	6.810,00€
TFVLIHMC 140	7.060,00€
TFVLIHMC 160	7.310,00€
TFVLIHMC 180	8.230,00€
TFVLIHMC 200	8.970,00€

TFVLMFHC • MUGA

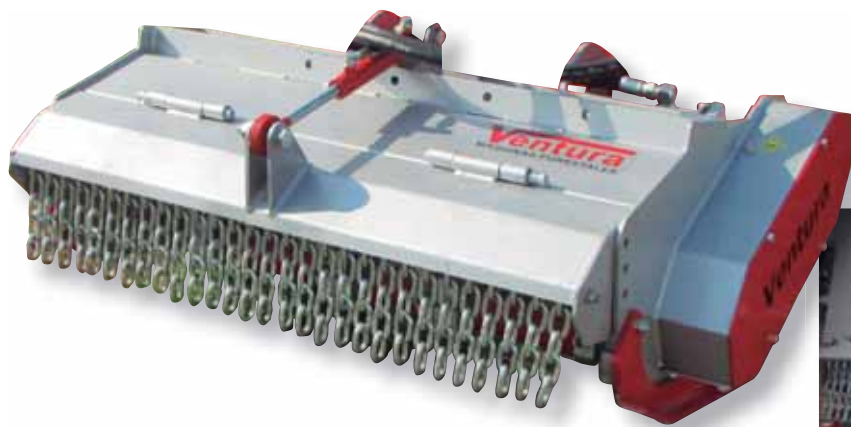

TFVLMFHC - TRITURADORAS HIDRÁULICAS LIGERAS PARA MINICARGADORA.













TFVLMFHC Trituradoras de martillos fijos de widia con motor hidráulico y transmisión por correas al eje. Para minicargadoras. Para ramas de hasta 12 cm de diámetro. Enganche para adaptación a minicargadoras.

TFVLMFHC - LIGHTWEIGHT HYDRAULIC MULCHERS TO FIT MINI LOADERS.

TFVLMFHC mulcher with fixed widia hammers equipped with an hydraulic pump and belt drive. Suitable for mini loader. For branches up to 12 cm diameter. Attachment for mini excavators and mini loader.

TFVLMFHC - BROYEUR HYDRAULIQUES LEGERS POUR MINICARGADORA.

TFVLMFHC Broyeur à marteaux fixes Widia avec moteur hydraulique et entraînement par arbre. Pour les mini chargeurs. Pour les branches jusqu'à 12 cm de diamètre. Attelage pour adaptation aux mini chargeurs.

		Modelos Model Modèle				
		TFVLMFHC 80	TFVLMFHC 100	TFVLMFHC 120	TFVLMFHC 140	TFVLMFHC 160
	Ancho trabajo Working Width Largeur travail	800	1000	1200	1400	1600
	Medidas exteriores Outer dimensions Mesures extérieures	Acm. Bcm. Ccm. 52 108 93	52 128 93	52 148 93	52 168 93	52 188 93
	Ø mm. Rotor con martillos Ø mm. Rotor with hammers Ø mm. Rotor avec marteaux	450	450	450	450	450
	Ø cm. máx. tronco Ø cm. máx. trunc Ø cm. max. tronc	12	12	12	12	12
	Martillos fijos vidia Fixed Widia Hammers Marteaux fixes Widia	18	20	24	28	30
	Peso Weight Poids	480	545	595	620	640
	Nº Correas Num. Belts Num. Courroies	4 B	4 B	4 B	4 B	4 B
	Caudal aceite Oil flow Débit d'huile	45-85	60-95	60-95	70-100	70-100
	Presión (BAR) Pressure (BAR) Pression (BAR)	180-200	180-200	180-200	180-200	180-200
	Protección delantera ront guard Protection frontal	Cadena Chain Chaîne				
	Protección trasera Back guard Protection arrière	Goma Rubber Gomme				
	Rodillo regulable altura Roller height adjust Rouleau réglable en hauteur	De serie Standard De série				
	Patín protecc. chasis Skids chasis protec. Patins protec chasis	De serie Standard De série				



PRECIO | PRICE | PRIX

TFVLMFHC 80	11.270,00€
TFVLMFHC 100	11.880,00€
TFVLMFHC 120	13.140,00€
TFVLMFHC 140	14.120,00€
TFVLMFHC 160	14.940,00€



TFVJMFHCL • WASCANA



TRITURADORA FORESTAL DE MARTILLOS FIJOS HIDRÁULICA PARA MINICARGADORA LIGERA

Trituradora forestal hidráulica con una chapa de alto rendimiento y martillo de vidia fijo para cargadoras ligeras, correas dentadas SPBX y motor de pistones.

Adecuado para todo tipo de maderas, jardinería y usos agrícolas.

Este modelo tiene un chasis más bajo, lo que le da más visibilidad al usuario.

HYDRAULIC FIXED HAMMER FORESTRY CRUSHER FOR LIGHT LOADER

Hydraulic forest crusher with a high performance sheet and fixed glass hammer for light loaders, SPBX timing belts and piston engine.

Suitable for all types of wood, gardening and agricultural uses.

This model has a lower chassis, which gives the user more visibility.













BROYEUR FORESTIER À MARTEAU HYDRAULIQUE POUR CHARGEUR LÉGER

Broyeur forestier hydraulique à tôle haute performance et marteau à verre fixe pour chargeuses légères, courroies SPBX et moteur à piston.

Convient à tous les types de bois, de jardinage et d'utilisations agricoles.

Ce modèle a un châssis inférieur, ce qui donne plus de visibilité à l'utilisateur.



		Modelos Model Modèle				
		TFVJMFHCL 130	TFVJMFHCL 150	TFVJMFHCL 180	TFVJMFHCL 200	TFVJMFHCL 225
	Ancho trabajo Working Width Largeur travail	1300	1500	1800	2000	2250
	Medidas exteriores Outer dimensions Mesures extérieures	Acm. 88 Bcm. 158 Ccm. 101	88 178 101	88 208 101	88 228 101	88 248 101
	Profundidad cm Depth cm Profondeur cm	7	7	7	7	7
	Ø mm. Rotor con martillos Ø mm. Rotor with hammers Ø mm. Rotor avec marteaux	460	460	460	460	460
	Ø cm. máx. tronco Ø cm. max. trunc Ø cm. max. trunc	20	20	20	20	20
	Martillos fijos vidia Fixed Widia Hammers Marteaux fixes Widia	22	26	30	34	36
	Peso Weight Poids	860	972	1074	1176	1278
	Nº Correas Num. Belts Num. Courroies	5	5	7	7	7
	Caudal aceite Oil flow Débit d'huile	80-120	80-120	80-120	80-120	80-120
	Presión (BAR) Pressure (BAR) Pression (BAR)	200-260	200-260	200-260	200-260	200-260
	Protección delantera ront guard Protection frontal	Cadena doble Double chain Chaîne double				
	Patín protecc. chasis Skids chasis protec. Patins protec chasis	De serie Standard De série				

PRECIO | PRICE | PRIX

TFVJMFHCL 130	17.410,00€
TFVJMFHCL 150	18.280,00€
TFVJMFHCL 180	19.320,00€
TFVJMFHCL 200	20.475,00€
TFVJMFHCL 225	20.965,00€

Opciones | Options | Options

Barra de tumbado Pushing bar Barre arrière	700,00€
Puerta hidráulica delantera (deduction) Hydraulic front door (Hoses not included) Frontal capot hydraulique (déduction)	- 470,00€
Electro válvula doble bobina accionamiento puerta hidráulica Electro valve double coil hydraulic door drive Entrainement de porte hydraulique à double bobine d'électrovanne	530,00€



TFVJCHC • FLINDERS













TRITURADORA FORESTAL EQUIPADA CON MOTOR HIDRÁULICO PREPARADA PARA ADAPTAR A MINICARGADORAS PARA TRONCOS DE HASTA Ø20 CM

FORESTRY MULCHER EQUIPPED WITH HYDRAULIC PUMP READY TO BE ATTACHED TO A MINILOADER FOR LOGS UP TO Ø20 CM

BROYEUR FORESTIER EQUIPÉ AVEC UN MOTEUR HYDRAULIQUE POUR L'ACCOUPLÉMENT SUR MINI-CHARGEUSES POUR TRONCS JUSQU'À Ø20 CM



		Modelos Model Modèle				
		TFVJMFHCL 130	TFVJMFHCL 150	TFVJMFHCL 180	TFVJMFHCL 200	TFVJMFHCL 225
	Ancho trabajo Working Width Largeur travail	1300	1500	1800	2000	2250
	Medidas exteriores Outer dimensions Mesures extérieures	Acm. 88 Bcm. 158 Ccm. 101	88 178 101	88 208 101	88 228 101	88 248 101
	Ø mm. Rotor con martillos Ø mm. Rotor with hammers Ø mm. Rotor avec marteaux	460	460	460	460	460
	Ø cm. máx. tronco Ø cm. máx. trunc Ø cm. max. tronc	20	20	20	20	20
	Cuchillas fijas Fixed blades Lames fixes	15	21	27	33	39
	Peso Weight Poids	865	977	1080	1180	1284
	Nº Correas Num. Belts Num. Courroies	5	5	7	7	7
	Caudal aceite Oil flow Débit d'huile	80-120	80-120	80-120	80-120	80-120
	Presión (BAR) Pressure (BAR) Pression (BAR)	200-260	200-260	200-260	200-260	200-260
	Protección delantera ront guard Protection frontal	Cadena doble Double chain Chaîne double				
	Patín protec. chasis Skids chasis protec. Patins protec chasis	De serie Standard De série				



PRECIO | PRICE | PRIX

TFVJCHC 130	16.410,00€
TFVJCHC 150	17.710,00€
TFVJCHC 180	19.030,00€
TFVJCHC 200	20.055,00€
TFVJCHC 250	21.070,00€

Equipamiento de serie | Standard equipment | Équipement standard

- Chapa antidesgaste rotor | Rotor with wear resistant steel | **Rotor en acier anti-usure**
- Motor hidráulico de pistones | Hydraulic piston engine | **Moteur hydraulique à pistons**

Opciones | Options | Options

Barra de tumbado | Pushing bar | **Barre arrière** 700,00€

Electro válvula doble bobina accionamiento puerta hidráulica | Electro valve double coil hydraulic door drive | **Entrainement de porte hydraulique à double bobine d'électrovanne** 530,00€





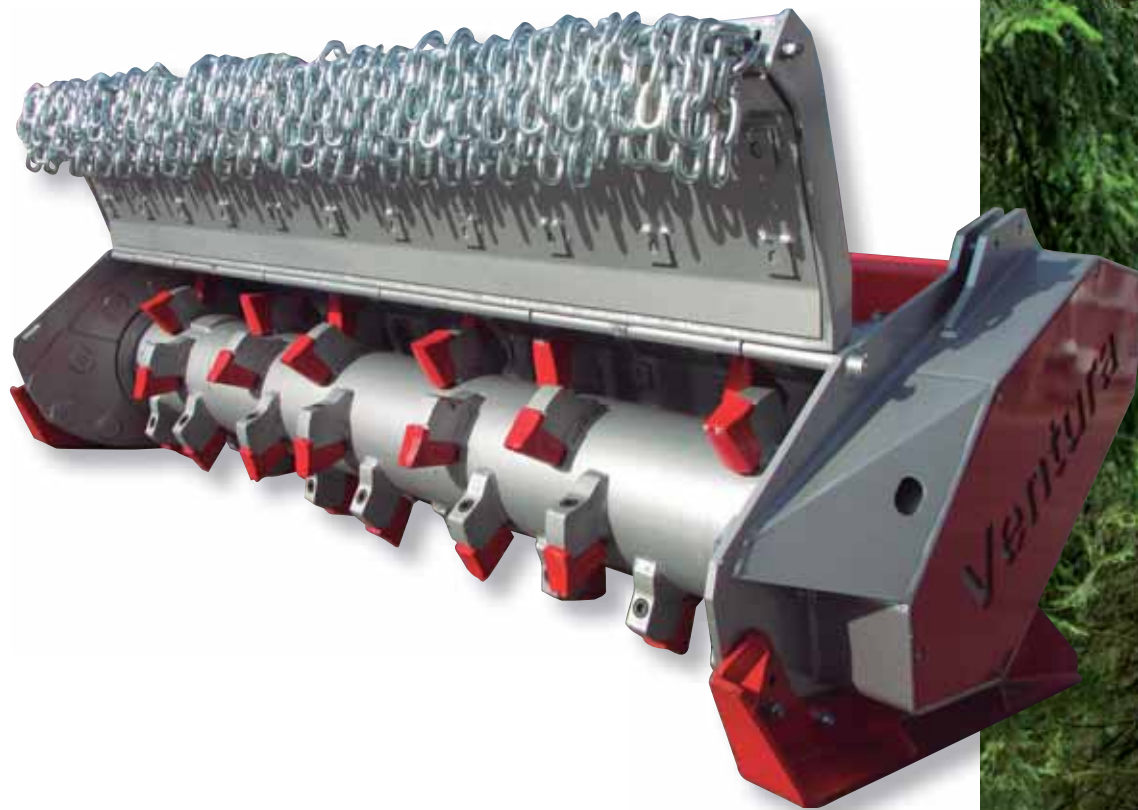









TFVMFHC • YATA



TRITURADORA FORESTAL DE MARTILLOS FIJOS CON PUNTA DE WIDIA EQUIPADA CON MOTOR HIDRÁULICO DE PISTONES PARA TRONCOS HASTA 30CM

FORESTRY MULCHER WITH FIXED WIDIA HAMMERS EQUIPPED WITH HYDRAULIC PUMP OF PISTONS FOR TRUNKS UP TO 30CM

BROYEUR FORESTIER À MARTEUX FIXES EN WIDIA EQUIPÉ AVEC UN MOTEUR HIDRAULIQUE POUR DE PISTONS POUR TRONCS JUSQU'À 30CM

		Modelos Model Modèle			
		TFVMFHC 180	TFVMFHC 200	TFVMFHC 225	TFVMFHC 250
	Ancho trabajo Working Width Largeur travail	1800	2000	2250	2500
	Medidas exteriores Outer dimensions Mesures extérieures	A cm. 110 B cm. 213 C cm. 112	110 233 112	110 258 112	110 283 112
	Profundidad cm Depth cm Profondeur cm	9	9	9	9
	Ø mm. Rotor con martillos Ø mm. Rotor with hammers Ø mm. Rotor avec marteaux	585	585	585	585
	Ø cm. máx. tronco Ø cm. máx. trunc Ø cm. max. tronc	30	30	30	30
	Martillos fijos vidia Fixed Widia Hammers Marteaux fixes Widia	28+2	32+2	34+2	38+2
	Peso Weight Poids	1608	1695	1785	1870
	Nº Correas Num. Belts Num. Courroies	6	6	6	6
	Caudal aceite Oil flow Débit d'huile	155	165	175	205
	Presión (BAR) Pressure (BAR) Pression (BAR)	200-260	200-260	200-260	200-260
	Protección delantera ront guard Protection frontal	Cadena doble Double chain Chaîne double			
	Patín protec. chasis Skids chasis protec. Patins protec chasis	De serie Standard De sérié			



PRECIO | PRICE | PRIX

TFVMFHC 180	25.690,00€
TFVMFHC 200	26.700,00€
TFVMFHC 225	27.710,00€
TFVMFHC 250	29.570,00€

Equipamiento de serie | Standard equipment | Équipement standard

· Motor hidráulico de pistones | Hydraulic piston engine | **Moteur hydraulique à pistons**

Opciones | Options | Options

Puerta hidráulica (latiguillos no incluidos)

Hydraulic rear door (Hoses not included)

Capot arrière à ouverture hydraulique (Flexibles not inclus) 470,00€

Electro válvula doble bobina accionamiento puerta hidráulica | Electro valve double coil

hydraulic door drive | **Entrainement de porte hydraulique à double bobine d'électrovanne** 530,00€



TPVH • HAN

TRITURADORA DE PIEDRA Y FRESADORA DE SUELOS, CAMINOS, PISTAS FORESTALES Y RECICLADORA DE PIEDRA. CONVIRTIENDO EN ARENA PARA LA PREPARACIÓN DEL TERRENO.

Equipamiento

- Construcción muy robusta para poder soportar los esfuerzos más intensos con chapa de alto límite elástico.
- Revestimiento en todo el bastidor y puerta trasera de chapa antidesgaste desmontable de fácil cambio.
- Tritura piedra de 1 a 20 cm.
- 13 cm de profundidad de fresado.
- Martillos de widia de tungsteno con tratamiento especial.
- Protecciones suficientes con doble cadena para salvaguardar la seguridad del operador.
- Fácil mantenimiento.
- Correas de transmisión SPBX dentadas.
- Puerta trasera hidráulica opcionalmente.
- Patines de acero anti-desgaste con una regulación de profundidad.
- Patines para trabajo de profundidad (de serie).
- Motor hidráulico de pistones.



STONE CRUSHER & SOIL STABILIZER, SUITABLE FOR CRUSHING STONES, SOIL MILLING, ROAD MAINTENANCE AND STONE RECYCLING. IT CONVERTS THE STONES INTO DUST IN ORDER TO FULFIL SITE PREPARATION PURPOSES.

Equipment

- Robust machine made in high yield steel chassis in order to withstand the most intense efforts
- Detachable anti-wear plate frame & back cover for easy changeover.
- Can crush stones from 1 to 20 cm.
- Milling depth 13 cm.
- Widia Hammers with tungsten tip, specially treated.
- Sufficient protections to safeguard the operator's safety.
- Easy maintenance.
- Timing Belts SPBX
- Hydraulic rear door optional.
- Skids made in anti-wear steel with depth settings.
- Depth setting skids (standard).
- Hydraulic piston motor.

BROYEUR DE PIERRES & STABILISATEUR DE SOL, CETTE MODEL EST CONÇUE POUR LE CONCASSAGE DES PIERRES, LE FRAISAGE DU SOL, L'ENTRETIEN DES ROUTES ET LE RECYCLAGE DES PIERRES. LA MACHINE SERT À DÉTRUIRE LA PIERRE I LA TRANSFORMER EN PETITES PARTICULES.

Équipement

- Machine robuste fabriquée avec un châssis en acier à haut rendement pour résister aux efforts les plus intenses.
- Cadre et capot arrière en acier anti-usure et amovibles pour une commutation facile.
- Peut écraser des pierres de 1 à 20 cm.
- Profondeur de fraisage de 13 cm.
- Marteaux en Widia avec pointe de tungstène Spécialement traités.
- Des protections suffi santes pour protéger la sécurité de l'opérateur.
- Entretien facile.
- Courroies de distribution SPBX
- Porte arrière hydraulique.
- Patins en acier anti-usure avec réglages de profondeur.
- Patins de réglage de profondeur (standard).
- Moteur à piston hydraulique.



		Modelos	Model	Modèle
		TPVH 200	TPVH 225	TPVH 250
	Ancho trabajo Working Width Largeur travail	2000	2250	2500
	Medidas exteriores Outer dimensions Mesures extérieures	A cm. 110 B cm. 236 C cm. 126	110 256 126	110 276 126
	Profundidad cm Depth cm Profondeur cm	13	13	14
	Ø cm. máx. piedra Ø cm. máx. stone Ø cm. max. pierre	20	20	20
	Martillos fijos vidia Fixed Widia Hammers Marteaux fixes Widia	32+2	34+2	38+2
	Peso Weight Poids	2520	2634	2750
	Nº Correas Num. Belts Num. Courroies	6	6	6
	Caudal recomendado Recommended working pressure Débit d'huile recommandée	165	175	205
	Ø mm. Rotor con martillos Ø mm. Rotor with hammers Ø mm. Rotor avec marteaux	585	585	585
	Presión máxima de trabajo (BAR) Maximum working pressure (BAR) Pression max. de travail (BAR)	200-260	200-260	200-260
	Protección delantera ront guard Protection frontal	Cadena doble Double chain Chaîne double		
	Patín protec. chasis Skids chasis protec. Patins protec chasis	De serie Standard De série		



PRECIO | PRICE | PRIX

TPVH 200	40.120,00€
TPVH 225	41.640,00€
TPVH 250	43.150,00€

Opciones | Options | Options

Puerta hidráulica Hydraulic door Capot à ouverture hydraulique	470,00€
Rodillo compactador de movimiento hidráulico hydraulic movement compactor roller Rouleau compacteur à mouvement hydraulique	5.880,00€
Barra de tumbado Pushing bar Barre pour tomber les arbres	700,00€
Barra de tumbado hidráulica Hydraulic pushing bar Barre pour tomber les arbres hydraulique	2.650,00€
Electro válvula doble bobina accionamiento puerta hidráulica Electro valve double coil hydraulic door drive entraînement de porte hydraulique à double bobine d'électrovanne	530,00€



TFMFHC • KET

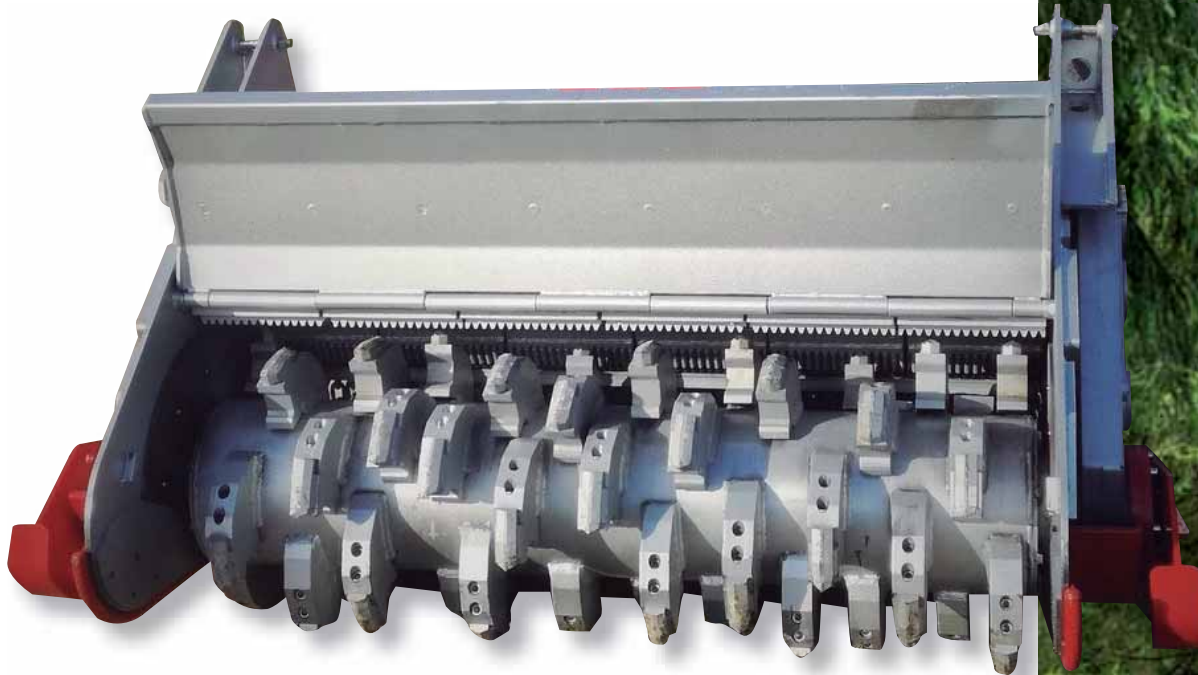

TRITURADORA FORESTAL DE MARTILLOS FIJOS CON PUNTA DE WIDIA EQUIPADA CON MOTOR HIDRÁULICO DE PISTONES PREPARADA PARA ADAPTAR A EXCAVADORAS Y MINICARGADORAS DE 10 A 20 TON. PARA TRONCOS DE HASTA Ø40CM

FORESTRY MULCHER WITH FIXED WIDIA HAMMERS EQUIPPED WITH HYDRAULIC PUMP OF PISTONS READY TO BE ATTACHED TO A EXCAVATOR OR MINILOADER FROM 10 TO 20 TON. FOR LOGS UP TO Ø40CM

BROYEUR FORESTIER À MARTEUX FIXES EN WIDIA EQUIPÉ AVEC UN MOTEUR HIDRAULIQUE DE PISTONS POUR L'ACCOUPLÉMENT SUR PELLES ET MINI CHARGEUSES DU 10 A 20 TON. POUR TRONCS JUSQU'À Ø40CM

		Modelos	Model	Modèle
		TFMFHC 200	TFMFHC 225	TFMFHC 250
	Ancho trabajo Working Width Largeur travail	2000	2250	2500
	Medidas exteriores Outer dimensions Mesures extérieures	A cm. 124 B cm. 242 C cm. 116	124 267 116	124 292 116
	Profundidad cm Depth cm Profondeur cm	15	15	15
	Ø mm. Rotor con martillos Ø mm. Rotor with hammers Ø mm. Rotor avec marteaux	675	675	675
	Ø cm. máx. tronco Ø cm. máx. trunc Ø cm. max. tronc	40	40	40
	Ø cm. máx. piedra Ø cm. máx. stone Ø cm. max. pierre	30	30	30
	Martillos fijos vidia Fixed Widia Hammers Marteaux fixes Widia	52+2	60+2	68+2
	Peso Weight Poids	2470	2590	2710
	Nº Correas Num. Belts Num. Courroies	6C	6C	6C
	Caudal recomendado Recommended working pressure Débit d'huile recommandée	190-340	190-340	190-340
	Presión máxima de trabajo (BAR) Maximum working pressure (BAR) Pression máx. de travail (BAR)	200-350	200-350	200-350
	Protección delantera ront guard Protection frontal	Cadena doble Double chain Chaîne double		
	Patín protecc. chasis Skids chasis protec. Patins protec chasis	De serie Standard De série		

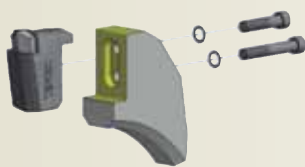

PRECIO | PRICE | PRIX

TFMFHC 200	39.500,00€
TFMFHC 225	42.500,00€
TFMFHC 250	44.800,00€

Equipamiento de serie | Standard equipment | Équipement standard

· Motor hidráulico de pistones | Hydraulic piston engine | **Moteur hydraulique à pistons**

Opciones | Options | Options

Barra de tumbado Pushing bar Barre pour tomber les arbres	1.750,00€
Barra de tumbado hidráulica Hydraulic pushing bar Barre pour tomber les arbres hydraulique	3.350,00€
Puerta trasera hidráulica Hydraulic rear door Capot arrière à ouverture hydraulique	750,00€
Patines para trabajo de profundidad Skids for depth work Patins pour travail en profondeur	596,00€
Rastrillo para barra de tumbado Pushing bar rakes Râteau sur la barre pour tomber les arbres	1.130,00€
Electro válvula doble bobina accionamiento puerta hidráulica Electro valve double coil hydraulic door drive Entrainement de porte hydraulique à double bobine d'électrovanne	530,00€







Desbrozadoras
Mowers
Girobroyeurs

A • LENISSEI



DESBROZADORA AGRÍCOLA CON CUCHILLAS O CADENAS

Las desbrozadoras de la serie A de construcción ligera adaptable a tractores de 20 a 90 cv de potencia. Idóneas para desbrozar hierba y maleza de hasta 7cm de diámetro máximo. Transmisión incluida.





AGRICULTURAL MOWER WITH BLADES OR CHAINS

The A series mowers have lightweight construction in order to adapt to tractors from 20 to 90 hp. Suitable for clearing grass, scrub and wood till a maximum of 7 cm diameter. Transmission included.

GIROBROYEUR SEMI-FORESTIER AVEC LAMES OU CHAINES

Les girobroyeurs modèle A sont de construction légère et conçus pour tracteurs de 20 – 90 Cv de puissance. Idéal pour couper l'herbe et la brousaille jusqu'à 7 cm de diamètre maximale. Cardan compris.



	Modelos		Model	Modèle		
	100 A	120 A	140 A	160 A	180 A	200 A
	540	540	540	540	540	540
	1000	1200	1400	1600	1800	2000
	2	2	2	2	2	2
	2	2	2	4	4	4
	155	178	195	420	440	695
	18-35	25-38	30-46	30-46	40-70	60-90



Cadenas | Chains | **Chaînes**



Cuchillas | Blades | **Lames**

PRECIO | PRICE | **PRIX**

100 A	1.335,00€
120 A	1.405,00€
140 A	1.512,00€
160 A	2.322,00€
180 A	2.900,00€
200 A	4.530,00€

Equipamiento de serie | Standard equipment | **Équipement standard**

Tranmisión incluida | Transmission included | **Cardan compris**

AC • DONETS



DESBROZADORA AGRÍCOLA CON CUCHILLAS

Las desbrozadoras de la serie AC de construcción muy robusta. Todo el bastidor es de chapa de 10 mm. Adaptables a tractores de 40cv hasta 140 cv. Preparadas para desbrozar malezas y maderas de 9 cm. Transmisión incluida.









AGRICULTURAL MOWER WITH BLADES

The AC series mowers are strong built. The entire frame is made of sheet metal 10 mm. Adaptable to 40cv tractors up to 140 hp. Ready to clear weeds and woods of 9 cm. Transmission included.

GYROBROYEUR AGRICOLE AVEC LAMES

Les girobroyeurs modèle AC sont de construction très robuste. L'ensemble du cadre est en tôle 10 mm. Adaptable aux tracteurs 40cv jusqu'à 140 ch. Prêt à éliminer les mauvaises herbes et bois de 9 cm. Transmission incluse.



		Modelos Model Modèle						
		210 AC	240 AC	260 AC	280 AC	300 AC	320 AC	360 AC
	Revol. min RPM TPM	540	540	540	540	540	540	540
	Ancho trabajo Working width Largeur travail	2100	2400	2600	2800	3.000	3.200	3.600
	Nº de cuchillas de corte Num. cutting hammers Nm. couteaux de coupe	4	4	4	4	4	4	4
	Peso Weight Poids	450	470	480	490	780	820	930
	Protección delantera Front guard Protection frontal	Metálica Metal Metal						
	Potencia tractor (min-max) Tractor power (min-max) Puissance tracteur (min-max)	40-80	40-80	40-80	40-80	80-100	90-120	100-140
	Patin protección chasis Skid protect. chassis Patin protection chassis	NO	NO	NO	NO	De serie Standard De serie		
	Enganche a tres puntos	2a	2a	2a	2a	2a	2a	2a
	TFT medidas PTO dimensions Measures prise de force	1 3/8 z=6	1 3/8 z=6	1 3/8 z=6	1 3/8 z=6	1 3/8 z=6	1 3/8 z=6	1 3/8 z=6

Los modelos AC sólo se sirven con cuchillas
AC models only available with blades
Modèles AC uniquement disponibles avec lames

Los modelos 210-240-260-280 AC llevan ruedas delanteras y rodillo trasero de serie
Models 210-240-260-280 AC carry front wheels and rear roller as standard
Modèles 210-240-260-280 AC avec roues avant et rouleau arrière de série



- Enganche a tres ptos. CAT-II | 3-point hitch. CAT-II | **Attelage 3-points, CAT-II**
- Grupo principal de 120 CV | Main gearbox – 120 HP | **Boitier principale – 120 CV**
- Grupos secundarios de 90 CV. | Secondary gearboxes 90 HP | **Boitiers secondaires 90 CV**
- Transmisión directa al plato | Direct transmission to rotor | **Cardan directe au rotor**
- Transmisión serie 106 con embrague. | Transmission serie 2016 with clutch | **Cardan série 106 avec embrayage**
- Velocidad del rotor 1040 r.p.m. | Rotor speed 1040 r.p.m | **Vitesse du rotor 1040 r.p.m.**
- Cadenas antiproyeccion delanteras y traseras | Front and rear anti-projection chains | **Chaînes anti-projections avant et arrière**
- Tripuntal oscilante | Oscillant 3 point hitch | **3 points oscillant**

PRECIO | PRICE | **PRIX**

210 AC	8.640,00€
240 AC	8.760,00€
260AC	8.850,00€
280 AC	8.910,00€
300 AC	10.665,00€
320 AC	10.865,00€
360 AC	11.610,00€

Equipamiento de serie | Standard equipment | **Équipement standard**

Transmisión incluida | Transmission included | **Cardan compris**

Opciones | Options | **Options**

Ruedas traseras mod. 300-320-360 AC
Rear wheels mod. 300-320-360 AC | **Roues arrière mod. 300-320-360 AC** 650,00€



ACB • MAYA

SEGADORA PARA LA TRITURACIÓN DE HIERBA PARA JARDINES, PARQUES, ÁREAS VERDES PARA MINI TRACTORES DE 15 A 70CV.

El equipamiento estándar incluye conexión de tres puntos Cat. 1 con soportes flotantes, transmisión de dos correas con tensor, cuatro ruedas pivotantes de apoyo de goma, profundidad de trabajo regulable mediante cuñas, punto de engrase centralizado, descarga posterior, eje cardan y rodillo anti desbroce.

Opcionalmente podemos incorporar, limitador de par de tornillo en el eje de cardán, rueda libre en el eje de cardán, ruedas neumáticas, versión de conexión frontal o frontal rápida.

MOWER FOR THE CRUSHING OF GRASS FOR GARDENS, PARKS, GREEN AREAS FOR MINI TRACTORS FROM 15 TO 70CV.

The standard equipment includes three-point linkage Cat. 1 with floating supports, transmission of two belts with tensioner, four pivoting wheels of rubber support, working depth adjustable by wedges, centralized lubrication point, rear discharge, cardan shaft and anti roller clearing

Optionally we can incorporate, screw torque limiter in the cardan shaft, freewheel in cardan shaft, pneumatic wheels, front or front quick connect version.

TONDEUSE POUR BROYER L'HERBE POUR JARDINS, PARCS, ESPACES VERTS POUR MINI TRACTEURS DE 15 À 70CV.

L'équipement standard comprend une connexion trois points Cat.1 avec des supports flottants, une transmission de deux courroies avec tendeur, quatre roues pivotantes de support en caoutchouc, une profondeur de travail réglable par des coins, un point de lubrification centralisé, une décharge arrière, un cardan et un anti-rouleau effacement

En option, nous pouvons intégrer un limiteur de couple à vis dans l'arbre à cardan, une roue libre dans l'arbre à cardan, des roues pneumatiques, une version à connexion rapide avant ou avant.



		Modelos Model Modèle			
		ACB 120	ACB 150	ACB 180	ACB 210
	Ancho trabajo Working Width Largeur travail	1200	1500	1800	2000
	Potencia tractor (min-max) Tractor power (min-max) Puissance tracteur (min-max)	15-40	15-40	25-50	35-70
	Cuchillas fijas Fixed blades Lames fixes	3	3	3	3
	Revol. min RPM TPM	540	540	540	540
	Medidas exteriores Outer dimensions Mesures extérieures	Acm. 128 Bcm. 52 Ccm. 82	158 64 88	188 77 88	218 99 95
	Peso Weight Poids	192	218	245	342



PRECIO | PRICE | PRIX

ACB 120	2.145,00€
ACB 150	2.192,00€
ACB 180	2.425,00€
ACB 210	3.390,00€

SF • SENEGAL

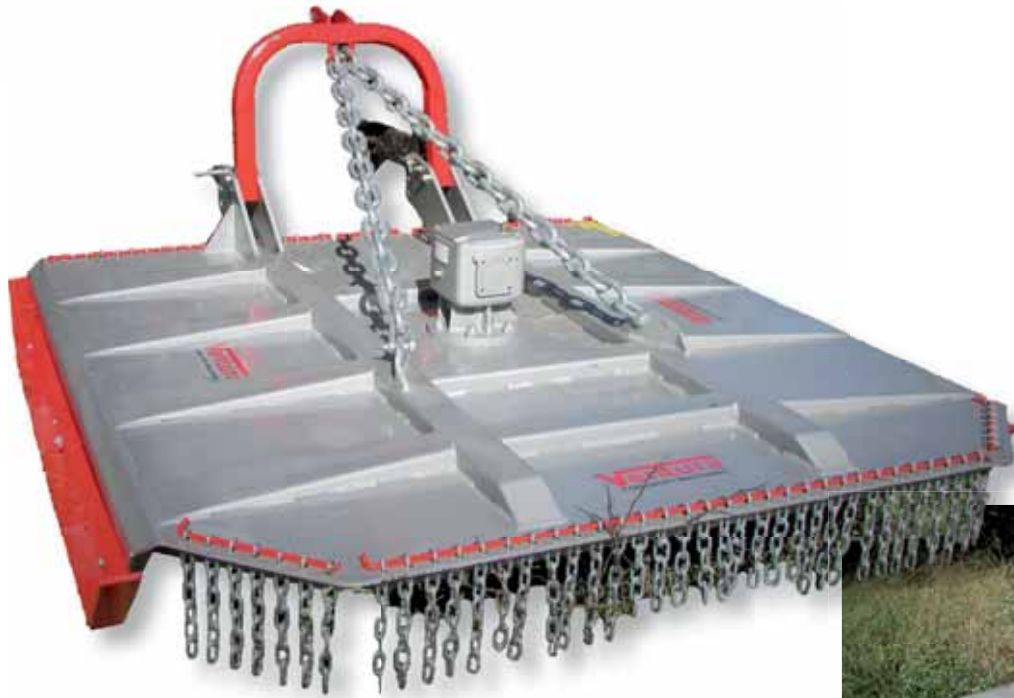

DESBROZADORA SEMIFORESTAL CON CUCHILLAS O CADENAS

Las desbrozadoras de la serie SF de construcción muy robusta. Todo el bastidor es de chapa de 10 mm. Adaptables a tractores de 50cv hasta 140 cv. Preparadas para desbrozar malezas y maderas de 14 cm. Transmisión incluida.







SEMI-FORESTRY MOWER WITH BLADES OR CHAINS

The SF series mowers are strong built in order to adapt to tractors from 50 - 140 HP. Plate thickness 10 mm. Suitable for cleaning scrub and wood till a maximum of 14 cm diameter. Transmision included.

GYROBROYEUR SEMI-FORESTIER AVEC LAMES OU CHAÎNES

Les girobroyeurs modèle SF sont de construction lourde et sont composé de tôle de 10mm. Sont étudiés pour tracteurs de 50 - 140 Cv de puissance. Idéal pour couper l'herbe et la broussaille jusqu'à 14 cm de diamètre maximale. Cardan compris.



		Modelos Model Modèle		
		160 SF	180 SF	200 SF
	Revol. min RPM TPM	540	540	540
	Ancho trabajo Working width Largeur travail	1.600	1.800	2.000
	Cuchillas Blades Couteaus	2	2	2
	Cadenas Chains Chaînes	4	4	4
	Peso Weight Poids	590	675	695
	Potencia tractor (min-max) Tractor power (min-max) Puissance tracteur (min-max)	50-110	60-120	90-140
	Protección delantera Front guard Protection frontal	Cadenas Chains Chaînes		



PRECIO | PRICE | PRIX

160 SF	3.430,00€
180 SF	3.942,00€
200 SF	4.530,00€

Equipamiento de serie | Standard equipment | Équipement standard

Transmisión incluida | Transmission included | **Cardan compris**

F • NILO



DESBROZADORA FORESTAL CON CUCHILLAS O CADENAS

Las desbrozadoras de la serie F de construcción ligera adaptable a tractores de 50 a 150 cv de potencia. Doble bastidor con chapa de 10 mm + 8 mm. Idóneas para desbrozar hierba y maleza de hasta 7 cm de diámetro máximo. Transmisión incluida.







FORESTRY MOWER WITH BLADES OR CHAINS

The F series mowers are very strong built in order to adapt to tractors from 50 - 150 HP. Double-layered steel plate. Plate thickness 10 mm + 8 mm. Suitable for cleaning scrub and wood till a maximum of 18 cm diameter. Transmission included.

GYROBROYEUR FORESTIER AVEC LAMES OU CHAÎNES

Les girobroyeurs modèle F sont de construction lourde et sont composé de double tôle en acier de 10 mm + 8 mm. Sont conçus pour tracteurs de 50 - 150 Cv de puissance. Idéal pour couper l'herbe et la broussaille jusqu'à 18 cm de diamètre maximale. Cardan compris.



		Modelos Model Modèle			
		130 F	160 F	180 F	200 F
	Revol. min RPM TPM	540	540	540	540
	Ancho trabajo Working width Largeur travail	1.300	1.600	1.800	2.000
	Cuchillas Blades Couteaus	2	2	2	2
	Cadenas Chains Chaînes	4	4	4	4
	Peso Weight Poids	560	730	820	840
	Potencia tractor (min-max) Tractor power (min-max) Puissance tracteur (min-max)	50-100	70-150	75-150	100-150
	Protección delantera Front guard Protection frontal	Cadenas Chains Chaînes			



PRECIO | PRICE | PRIX

130 F	3.595,00€
160 F	4.970,00€
180 F	5.124,00€
200 F	5.232,00€

Equipamiento de serie | Standard equipment | Équipement standard

Tranmisión incluida | Transmission included | **Cardan compris**

Opciones | Options | Options

Núcleo completo de cadenas o cuchillas

Complete core of chains or blades | **Noyau complet de chaînes ou lames**

980,00€

ACPL • CONGO



Se trata de una desbrozadora de doble plato rotor semi-forestal con un grupo principal que transmite la potencia a dos grupos secundarios los que accionan los platos portacadenas.

La desbrozadora ACPL es una máquina de estructura reforzada con laterales abatibles para poder circular por vía pública. Su campo de aplicación es la limpieza de parcelas, acondicionamiento y repaso de pastos, limpiezas semi-forestales en zonas de matorrales y monte bajo, y cualquier trabajo de desbroce donde se precise de un rendimiento alto con tractores de caballaje medio y alto.

Mower equipped with double plate semi-forestry rotor. Includes a main gearbox that transmit the power to 2 secondary gearboxes which activate the chain-holder rotors.

The ACPL mower is a robust machine with strengthened lateral flip-ups so that it can be able to circulate on the road.

Its field of application is the cleaning of plots, conditioning and overhaul of pastures and semi-forest clearings in bush areas.

Suitable for high performance clearing works where medium and high horsepower tractors are required.











Gyrobroyeur équipée d'un rotor semi-forestier à double plaque. Comprend une boîte principale qui transmet la puissance à 2 boîtiers secondaires qui activent les rotors porte-chaîne.

Le Gyrobroyeur ACPL est une machine robuste avec des flip-ups latéraux renforcés afin qu'il puisse circuler sur la route.

Son champ d'application est le nettoyage des parcelles, le conditionnement des pâturages et les travaux semi-forestiers dans les zones de brousse.

Idéale pour les travaux de débroussaillage à haut rendement où des tracteurs à puissance moyenne et élevée sont nécessaires.



		Modelos Model Modèle			
		ACPL 280	ACPL 300	ACPL 320	ACPL 350
	Ancho trabajo Working width Largeur travail	2.800	3.000	3.200	3.500
	Nº de cuchillas de corte Num. cutting hammers Nm. couteaux de coupe	4	4	4	4
	Cadenas Chains Chaines	8	8	8	8
	Potencia tractor (min-max) Tractor power (min-max) Puissance tracteur (min-max)	90-120	95-125	105-135	120-155
	Peso Weight Poids	760	805	835	950
	Protección delantera Front guard Protection frontal	Metálica Metal Metal			
	Enganche a tres puntos	2a	2a	2a	2a
	TFT medidas PTO dimensions Mesures prise de force	1 3/8 z=6	1 3/8 z=6	1 3/8 z=6	1 3/8 z=6
	Revol. Min RPM TPM	540	540	540	540
	Patin protección chasis Skid protect. chassis Patin protection chassis	De serie Standard De serie			

Los modelos ACPL sólo se sirven con cuchillas
ACPL models only available with blades
Modèles ACPL uniquement disponibles avec lames

- Enganche a tres ptos. CAT-II | 3-point hitch. CAT-II | **Attelage 3-points, CAT-II**
- Grupo principal de 120 CV | Main gearbox – 120 HP | **Boitier principale – 120 CV**
- Grupos secundarios de 90 CV. | Secondary gearboxes 90 HP | **Boitiers secondaires 90 CV**
- Transmisión directa al plato | Direct transmission to rotor | **Cardan directe au rotor**
- Transmisión serie 106 con embrague. | Transmission serie 2016 with clutch | **Cardan série 106 avec embrayage**
- Velocidad del rotor 1040 r.p.m. | Rotor speed 1040 r.p.m | **Vitesse du rotor 1040 r.p.m.**
- Cadenas antiproyeccion delanteras y traseras | Front and rear anti-projection chains | **Chaines anti-projections avant et arrière**
- Laterales abatibles hidráulicos | Lateral hydraulic flip-ups | **Flip-ups latéraux hydrauliques**
- Tripuntal oscilante | Oscillant 3 point hitch | **3 points oscillant**

PRECIO | PRICE | PRIX

ACPL 280	9.990,00€
ACPL 300	10.400,00€
ACPL 320	10.590,00€
ACPL 350	11.070,00€

Equipamiento de serie | Standard equipment | **Équipement standard**

Rodillo trasero | Rear roller | **Rouleau arrière**

Ruedas traseras s/cargo | Rear wheels | **Roues arrière**

Opciones | Options | **Options**

Kit cuchillas intercambiables | Kit blade - interchangeable | **Kit de lames interchangeable**



ACP 400-600 • SEPIK



Desbrozadora profesional de doble plato rotor semi-forestal con un grupo principal que transmite la potencia a dos grupos secundarios los que accionan los platos portacadenas. La desbrozadora ACP es una máquina de estructura reforzada para profesionales con laterales abatibles. Su campo de aplicación es la limpieza de parcelas, acondicionamiento y repaso de pastos, limpiezas semi-forestales en zonas de matorros y monte bajo, y cualquier trabajo de desbroce donde se precise de un rendimiento alto.

Mower equipped with double semi-forestry PLATE rotor. Includes a main gearbox that transmit the power to 2 secondary gearboxes which activate the chain-holder rotors. The ACP mower is a robust machine with strengthened lateral flip-ups. Its field of application is the cleaning of plots, conditioning and overhaul of pastures, semi-forest clearings in bush areas. Suitable for high performance clearing works where medium and high horsepower tractors are required.

Gyrobroyeur équipée d'un rotor semi-forestier à double plaque. Comprend une boîtier principale qui transmet la puissance à 2 boîtiers secondaires qui activent les rotors porte-chaîne. Le Gyrobroyeur ACPL est une machine robuste avec des flip-ups latéraux renforcés. Son champ d'application est le nettoyage des parcelles, le conditionnement des pâturages et les travaux semi-forestières dans les zones de brousse. Idéale pour les travaux de débroussaillage à haut rendement où des tracteurs à puissance moyenne et élevée sont nécessaires.

		Modelos	Model	Modèle
		ACP 400	ACP 600	
	Ancho de trabajo Working width Largeur travail	4.000	6.000	
	Nº de cuchillas de corte Num. cutting hammers Num. couteaux de coupe	4	6	
	Cadenas Chains Chaines	8	8	
	Potencia tractor (min-max) Tractor power (min-max) Puissance tracteur (min-max)	130-160	100-200	
	Peso Weight Poids	1120	3420	
	Protección delantera Front guard Protection frontal	De serie Standard De serie		
	Enganche a tres puntos	2a	2a	
	TFT medidas PTO dimensions Measures prise de force	1 3/8 z=6	1 3/8 z=6	
	Revol. Min RPM TPM	1000	1000	
	Patin protección chasis Skid protect. chassis Patin protection chassis	De serie Standard De serie		



PRECIO | PRICE | PRIX

ACP 400

13.500,00€

ACP 600

FR • RIN



DES BROZADORA FORESTAL DE UN NÚCLEO FR

El nuevo modelo de desbrozadora FR ofrece patines regulables, transmisión de embrague, TFT de 540 o 1000RPM, rotor con 4 cadenas, grupo Bondioli Pavessi 3100. Su estructura es robusta con un chasis de 10mm y un cabezal fijo. Opcionalmente podemos suministrarla con desplazamiento hidráulico.







SINGLE CORE FOREST SLASHER

The new model of FR slasher offers adjustable skids, clutch transmission, TFT 540 or 1000RPM, rotor with 4 chains, Bondioli Pavessi 3100 group. Its structure is robust with a 10mm chassis and a fixed head. *Optionally we can supply it with hydraulic displacement.

DÉBROUSSAILLEUSE FORESTIÈRE À NOYAU

Le nouveau modèle de débroussailleuse FR propose des patins réglables, une transmission à embrayage, 540 ou 1000 tr / min TFT, un rotor à 4 chaînes, le groupe Bondioli Pavessi 3100. Sa structure est robuste avec un châssis de 10 mm et une tête fixe. En option, nous pouvons le fournir avec déplacement hydraulique.



		Modelos Model Modèle		
		FR 1800	FR 1900	FR 2000
	Ancho trabajo Working width Largeur travail mm	1800	1900	2000
	Potencia tractor (min-max) Tractor power (min-max) Puissance tracteur (min-max)	70-120	70-120	70-120
	Peso Weight Poids	920	960	1000
	Cadenas Chains Chaînes	4	4	4
	Cuchillas Knives Lames	2	2	2
	Protección delantera Front guard Protection frontal	Cadenas Chains Chaînes		



PRECIO | PRICE | PRIX

FR 1800	7.912,00€
FR 1900	8.099,00€
FR 2000	8.290,00€

Opciones | Options | Options

Desplazamiento hidráulico Hydraulic displacement Déplacement hydraulique	1.800,00€
--	-----------

F2NL • OBI



DESBROZADORA FORESTAL DE DOBLE NÚCLEO

El nuevo modelo de desbrozadora F2NL ofrece patines regulables, transmisión de embrague, TFT de 540 o 1000RPM, rotor con 4 cadenas, Su estructura es robusta y ofrece un cabezal fijo. Opcionalmente podemos suministrarla con desplazamiento hidráulico, patines redondos, puerta trasera hidráulica o tumbador.

FOREST SLASHER OF DOUBLE CORE

The new model of forest slasher F2NL offers adjustable skids, clutch transmission, TFT 540 or 1000RPM, rotor with 4 chains. His structure is robust and offers a fixed head. Optionally we can supply it with hydraulic displacement, round skates, hydraulic rear door.

DÉBROUSSAILLEUSE FORESTIÈRE DOUBLE NOYAU

Le nouveau modèle de débroussailleuse F2NL propose des patins réglables, une transmission à embrayage, TFT 540 ou 1000 tr / min, un rotor à 4 chaînes, sa structure est robuste et offre une tête fixe. En option, nous pouvons le fournir avec déplacement hydraulique, patins ronds, gobelet de porte arrière hydraulique.



		Modelos Model Modèle								
		F2NL 1600	F2NL 1700	F2NL 1800	F2NL 1900	F2NL 2000	F2NL 2200	F2NL 2300	F2NL 2400	F2NL 2500
	Revol. min RPM TPM	540	540	540	540	540	540	540	540	540
	Ancho trabajo Working width Largeur travail mm	1600	1700	1800	1900	2000	2200	2300	2400	2500
	Potencia tractor (min-max) Tractor power (min-max) Puissance tracteur (min-max)	60-80	60-80	60-80	80-100	80-100	70-110	70-110	70-120	70-120
	Peso Weight Poids	600	650	700	750	800	1100	1150	1200	1250
	Cadenas Chains Chaînes	8	8	8	8	8	8	8	8	8
	Cuchillas Blades Couteaus	4	4	4	4	4	4	4	4	4
	Protección delantera Front guard Protection frontal	Cadenas Chains Chaînes								



PRECIO | PRICE | **PRIX**

F2NL 1600	9.492,00€
F2NL 1700	9.678,00€
F2NL 1800	9.870,00€
F2NL 1900	10.061,00€
F2NL 2000	10.253,00€
F2NL 2200	14.666,00€
F2NL 2300	15.066,00€
F2NL 2400	15.468,00€
F2NL 2500	15.867,00€

Opciones | Options | **Options**

Desplazamiento hidráulico Hydraulic displacement Déplacement hydraulique	1.800,00€
Puerta trasera hidráulica Hydraulic rear door Porte arrière hydraulique	1.350,00€
Tumbador Rear pushing bar Barre de poussée arrière	900,00€



F2N • DRAA



DESBRIZADORA FORESTAL CON DOBLE GRUPO

La serie F2N tiene un bastidor de chapa acerada de 10mm y doble chapa acerada de 8 mm. Es la gama más alta en robustez y en producción de trabajo. Equipadas con 3 grupos y 2 núcleos de cadenas y cuchillas. Adaptable a tractores de 70 a 160 cv. Transmisión incluida. Desplazamiento hidráulico opcional.

FORESTRY MOWER WITH DOUBLE GROUP







The F2N series has a 10mm steel plate frame and 8mm steel double plate. It is the highest range in robustness and work production. Equipped with 3 gear-box and 2 chains and blade cores.

Adaptable to tractors from 70 to 160 hp. Transmission included and optional displacement hydraulic.

GIROBROYEUR FORESTIER AVEC 2 ROTORS

Les girobroyeurs modèle F2N sont de construction lourde et sont composé de double tôle en acier de 10mm et 8mm. C'est la gamme plus haute en robustesse et en production de travail. Equipés de 3 boîtiers de renvoi d'angle et 2 ensembles de chaînes ou lames. Sont étudiés pour tracteurs de 70 - 160 Cv de puissance. Cardan inclus. Déport hydraulique en option.



		Modelos Model Modèle			
		205 F2N	220 F2N	240 F2N	260 F2N
	Revol. min RPM TPM	540	540	540	540
	Ancho trabajo Working width Largeur travail	2050	2200	2400	2600
	Cuchillas Blades Couteaus	4	4	4	4
	Cadenas Chains Chaînes	8	8	8	8
	Peso Weight Poids	1200	1250	1350	1450
	Potencia tractor (min-max) Tractor power (min-max) Puissance tracteur (min-max)	70-85	110-130	120-130	130-160
	Protección delantera Front guard Protection frontal	Cadenas Chains Chaînes			



PRECIO | PRICE | PRIX

205 F2N	16.060,00€
220 F2N	16.460,00€
240 F2N	17.260,00€
260 F2N	18.070,00€

Opciones | Options | Options

Desplazamiento hidráulico serie F2N Hydraulic displacement F2N series Déplacement hydraulique serie F2N	2.080,00€
--	-----------

ACL 750 • AMAZONAS



Desbrozadora diseñada para ser conectada detrás del tractor y utilizarla en senderos. Para el montaje frontal o para tractores con conducción de marcha atrás se podrá pedir siempre bajo pedido, indicando las RPM y la dirección de la rotación del PTO. El ajuste de la caja de cambios es a 540 RPM y podría ser a 750/1000 RPM siempre bajo pedido.

Mower designed to be connected behind the tractor and used on trails. For frontal mounting or for tractors with reverse driving, it can always be ordered upon request, indicating the RPM and the direction of rotation of the PTO. The gearbox setting is at 540 RPM and could be at 750/1000 RPM always on request.

Girobroyeurs conçue pour être connectée derrière le tracteur et utilisée sur les sentiers. Pour le montage frontal ou pour les tracteurs à marche arrière, il peut toujours être commandé sur demande, en indiquant le régime et le sens de rotation de la prise de force. Le réglage de la boîte de vitesses est à 540 tr / min et pourrait être à 750/1000 tr/min toujours sur demande.



Modelos | **Model** | **Modèle**

		ACL 750
	Ancho trabajo Working width Largeur travail	750 mm
	Cuchillas Blades Lames	2
	Potencia tractor (min-max) Tractor power (min-max) Puissance tracteur (min-max)	30-110 cv/hp
	Velocidad de trabajo (min-max) Working speed (min-max) Vitesse de travail (min-max)	1-25 km
	Peso Weight Poids	390 kg
	TFT PTO RPM Mesures prise de force	540 g/m
	TFT medidas PTO dimensions Mesures prise de force	1 3/8
	Patin protección chasis Skid protect. chassis Patin protection chassis	De serie Standard De serie
	Enganche a 3 puntos Third point linkage Attelage 3 points	Cat 2
	Medidas (trabajo) Dimensions (working) Mesures (travail)	2208 x 2965 x 950 mm
	Medidas (transporte) Dimensions (travel) Mesures (transport)	2212 x 1370 x 950 mm



PRECIO | **PRICE** | **PRIX**

ACL 750

7.785,00€

DH • FLY



DESBROZADORA HIDRÁULICA

Máquinas diseñadas para el montaje en excavadoras (giratorias) de ruedas u orugas y minicargadoras, su diseño simple y el diseño compacto permite facilitar su uso en condiciones adversas forestales, también el sistema de corte ha sido calculado para una máquina de absorción de energía baja. Estas máquinas son ideales para el pulido, limpieza y mantenimiento de las áreas forestales de difícil acceso, capaz de cortar y pulir los árboles pequeños y arbustos.













HYDRAULIC MOWER

Machines designed to be mounted on wheeled or tracked excavators (rotating) and skid-steers. Its simple and compact design makes them suitable for adverse forest working conditions. The DH cutting system has been designed and calculated for a low-level energy absorption machine. The DH mowers are suitable for cleaning inaccessible forest areas and are capable of cutting and polishing small trees and shrubs.

GIROBROYEUR HIDRAULIQUE

Machines conçues pour montage sur pelles rotatives, à roues ou à chenille et mini chargeuses. Les gyrobroyeurs modèle DH sont de conception simple et compacte qui permet une utilisation facile dans des conditions forestières difficiles. Son système de coupe a été étudié pour une faible absorption d'énergie. Les gyrobroyeurs modèle DH sont idéales pour le nettoyage et l'entretien des zones forestières difficile d'accès, et sont étudiés pour la coupe de petits arbres et arbustes.



		Modelos	Model	Modèle
		DH 80	DH 120	DH 150
	Ancho de corte Cutting width Largeur de coupe	800 mm	1.200 mm	1.550 mm
	Ancho exterior Outer width Largeur extérieur	900	1.300 mm	1700 mm
	Sist. corte cadenas Chain cutting system Système de coupe avec de chaînes	2 un - Gr80-13	4 un - Gr80-16	4 un - Gr80-19
	Sist. fijación cadenas Belt fixation system Système de fixation des chaînes	Enganche rápido Systeme d'atta- che rapide	Enganche rápido Systeme d'atta- che rapide	Enganche rápido Systeme d'atta- che rapide
	Disco doble Double disk Disque double	ok	ok	ok
	Grupo engranajes motor hidráulico Gear pump hydraulic motor Groupe engranage moteur hydrau.	30 CV-GR2	60 CV-GR3	60 CV-GR3
	Potencia recom. máquina Recommended power Puissance recommandée	2,5/3,5 ton	3,5/7 ton	7/20 ton
	Caudal recomendado Recommended working pressure Débit d'huile recommandée	40-60 l	40-80 l	50-100 l
	Rotación trabajo recomendado (máx.) Recommended working rotation (max.) Vitesse max. de rotation de travail	1800 Rpm	1800 Rpm	1800 Tpm
	Presión máxima de trabajo Maximum working pressure Pression máx. de travail	180 Bar	200 Bar	200 Bar
	Patines regulación altura corte Skids with adjustable cutting height Patins pour régler la hauteur de coupe	2 posiciones 2 positions 2 positions	2 posiciones 2 positions 2 positions	2 posiciones 2 positions 2 positions
	Peso Peso Poids	180 kg	320 kg	550 kg



PRECIO | PRICE | PRIX

DH 80	3.341,00 €
DH 120	4.680,00 €
DH 150	6.030,00 €

Opciones | Options | Options

Enganche para minicargadora Connection for miniloaders Accouplement pour mini chargeuses	600,00 €
Enganche para excavadora Connection for excavators Accouplement pour excavateur/pelles	730,00 €
Latiguillos incluidos Hoses included Flexibles inclus	



DLB 410 • DADU



Las trituradoras de cadena Ventura DLB 410 han sido diseñadas para manejar incluso las condiciones más duras y difíciles. Este modelo tiene su propio brazo con un alcance de 410 centímetros desde la línea central del tractor. Se puede montar en una cargadora o excavadora forestal normal, lo que permite que la trituradora de cadena alcance las barandas y otros obstáculos en el lado de la carretera.

Las trituradoras de cadena son la herramienta ideal para mantener limpios los lados de los campos y para la contratación. La demanda de segar los costados de las carreteras continúa creciendo cada año. Las trituradoras de cadena también se pueden usar para mantener la tierra libre de matorrales y arbustos.

The Ventura DLB 410 chain mulchers have been engineered to handle even the toughest and rockiest conditions. This model has its own boom with an outreach of 410 centimetres from the centre line of the tractor. Can be mounted on a regular forest loader or digger, allowing the chain mulcher to reach over railings and other obstacles on the road side.

Chain mulchers are the ideal tool for keeping the sides of fields clean and for contracting. The demand for mowing road sides continues to grow with each year. Chain mulchers can also be used to keep fallow land free of brushwood and shrubbery.

Les Girobroyeurs à chaîne Ventura DLB 410 ont été conçus pour gérer même les conditions les plus difficiles et les plus rocheuses. Ce modèle possède sa propre flèche avec une portée de 410 centimètres par rapport à la ligne médiane du tracteur. Peut être monté sur une chargeuse forestière ou une pelle ordinaire, permettant au broyeur à chaîne d'atteindre par-dessus les garde-corps et autres obstacles sur le bord de la route.

Les broyeurs à chaîne sont l'outil idéal pour garder les côtés des champs propres et pour contracter. La demande de tonte des bords de route continue de croître chaque année. Les broyeurs à chaîne peuvent également être utilisés pour maintenir les jachères exemptes de broussailles et d'arbustes.

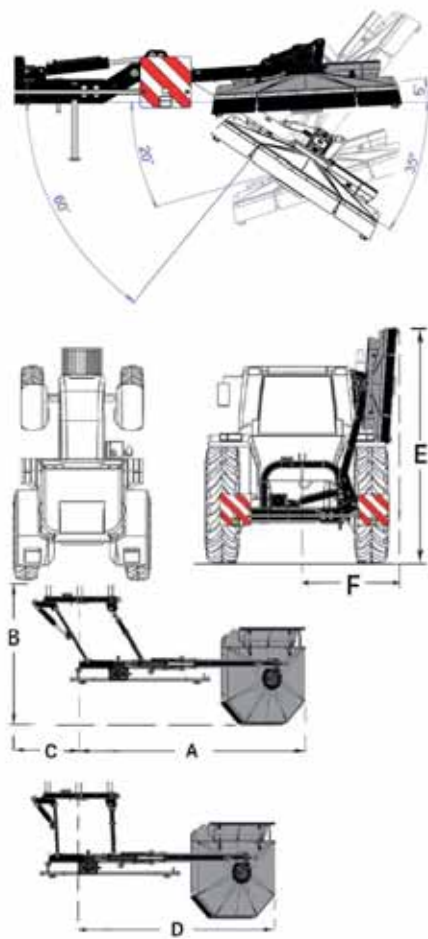

	A (cm)	B (cm)	C (cm)	D (cm)	E (cm)	F (cm)
DLB 410	410	210	75	306	327	123



		Modelos Model Modèle
		DLB 410
	Ancho de trabajo Working width Largeur travail	1500
	Nº de cuchillas de corte Num. cutting hammers Nm. couteaux de coupe	2
	Potencia tractor (min-max) Tractor power (min-max) Puissance tracteur (min-max)	80-140
	Peso Weight Poids	770
	Protección trasera Rear protection Protection arrière	Goma Rubber Gomme
	Enganche a tres puntos	2a
	TFT medidas PTO dimensions Measures prise de force	1 3/8 z=6
	Revol. Min RPM TPM	540
	Largo de trabajo Working length Longueur de travail	410



PRECIO | PRICE | PRIX

DLB 410 10.900,00€

Equipamiento de serie | Standard equipment | Équipement standard

- Enganche a tres ptos. CAT-II | 3-point hitch. CAT-II | **Attelage 3-points. CAT-II**
- Grupo principal de 120 CV | Main gearbox – 120 HP | **Boitier principale – 120 CV**
- Grupos secundarios de 90 CV | Secondary gearboxes 90 HP | **Boitiers secondaires 90 CV**
- Transmisión directa al plato | Direct transmission to rotor | **Cardan directe au rotor**
- Transmisión serie 106 con embrague | Transmission serie 2016 with clutch | **Cardan série 106 avec embrayage**
- Velocidad del rotor 1500 r.p.m. | Rotor speed 1500 r.p.m. | **Vitesse du rotor 1500 r.p.m.**
- Cadenas antiproyeccion delanteras y traseras | Front and rear anti-projection chains | **Chaines anti-projections avant et arrière**

Opciones | Options | Options

Kit cuchillas intercambiables | Kit bade- interchangeable
Kit de lames interchangeablebkes 145,00€

ADL • MILK

SEGADORA DE HIERBA CON DISCO LATERAL PARA LA VARIACIÓN DE ANCHO DE CORTE

La segadora de hierba con disco lateral es un producto de alta calidad, compacta, robusta y con una superficie lisa que garantiza la máxima fiabilidad y exigencia en cualquier campo. Su brazo lateral garantiza el ajuste de la amplitud de trabajo y su ancho de trabajo es ajustable hidráulicamente de forma continua. La transmisión básica de la máquina es de cajas de engranajes. Es una máquina equipada con rodillos delanteros y grandes ruedas traseros (Ø 200 mm) de altura ajustable. Los discos deslizantes (libres en cojinetes) montados debajo los brazos laterales y libremente móviles (arriba y abajo) proporcionan una adaptación óptima a la irregularidad del terreno. El tercer punto con cadena flotante permite a la máquina seguir perfectamente en el suelo. Para el funcionamiento de esta máquina, el tractor necesita una unidad de control de doble acción.

OPCIONAL

- El ajuste de la caja de cambios es a 540 RPM y podría ser a 750/1000 RPM siempre bajo pedido.
- La máquina está diseñada para ser conectada detrás del tractor y se utiliza en sendero. El montaje frontal o para tractores con conducción de marcha atrás se puede pedir siempre bajo pedido, indicando las RPM y la dirección de rotación del PTO).
- Ruedas neumáticas opcional

GRASS MOWER WITH SIDE DISK FOR THE VARIATION OF WIDTH OF CUT

The grass mower with side disc is a High quality product, compact, robust and with a smooth surface that guarantees maximum reliability and demand in any field. Its side arm guarantees the adjustment of the Working width and working width is hydraulically adjustable continuously. The Basic machine transmission is from boxes of gears It is a machine equipped with rollers front and large rear wheels (Ø 200 mm) height adjustable. Sliding discs (free in bearings) mounted under the arms lateral and freely movable (up and down) provide optimal adaptation to irregularity of the land The third point with chain floating allows the machine to follow perfectly on the floor. For the operation of this machine, the tractor needs a unit Double action control.

OPTIONAL

- The gearbox setting is at 540 RPM and it could be at 750/1000 RPM always on request.
- The machine is designed to be connected behind the tractor and used on the trail. The front mounting or for tractors with driving reversing can always be ordered under order, indicating the RPM and the direction of rotation of the PTO).
- Optional pneumatic wheels



TONDEUSE À HERBE AVEC DISQUE LATÉRAL POUR LA VARIATION DE LA LARGEUR DE COUPE

La tondeuse à gazon à disque latéral est un Produit de haute qualité, compact, robuste et avec une surface lisse qui garantit un maximum fiabilité et demande dans tous les domaines. Son bras latéral garantit le réglage de la La largeur de travail et la largeur de travail est réglable hydrauliquement en continu. La transmission de base de la machine provient de boîtes de engrenages C'est une machine équipée de rouleaux roues avant et arrière larges (Ø 200 mm) réglable en hauteur. Disques coulissants (libre dans les roulements) monté sous les bras latéral et librement mobile (de haut en bas) fournir une adaptation optimale à l'irrégularité de la terre Le troisième point avec chaîne flottant permet à la machine de suivre parfaitement par terre. Pour le fonctionnement de cette machine, le tracteur a besoin d'une unité Contrôle à double action.

EN OPTION

- Le réglage de la boîte de vitesses est à 540 tr / min et cela pourrait être à 750/1000 tr / min toujours sur demande.
- La machine est conçue pour être connectée derrière le tracteur et utilisé sur le sentier. Il montage avant ou pour tracteurs avec conduite l'inversion peut toujours être commandée sous ordre, indiquant le régime et le sens de rotation de la prise de force).
- Roues pneumatiques en option

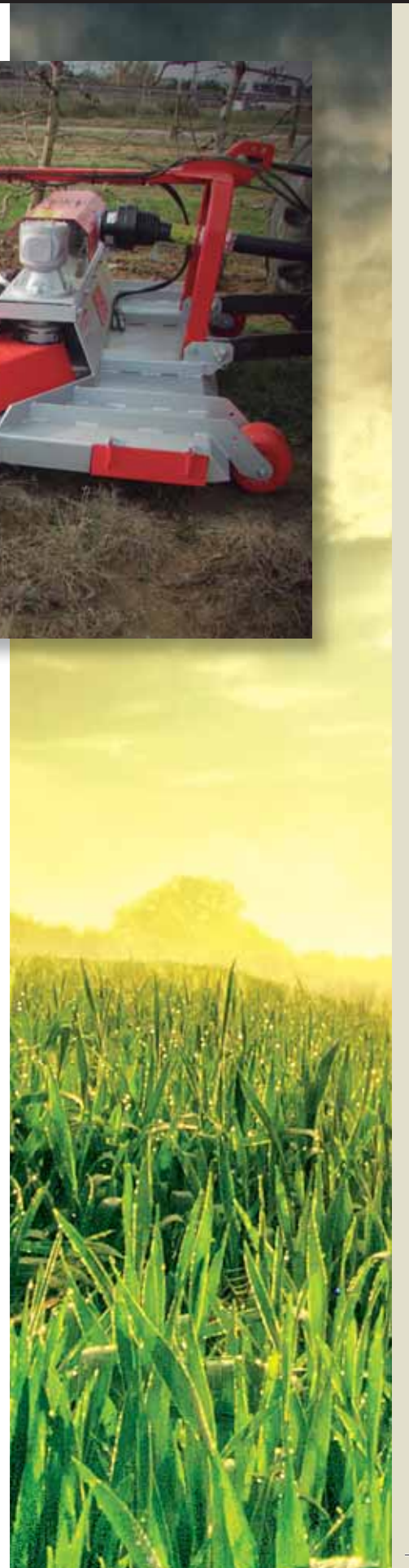

Modelos | Model | Modèle

	ADL 190	ADL 220	ADL 250	ADL 300
	1900	2200	2500	3000
	3	3	3	3
	3	3	3	3
	50-90	50-90	50-100	60-120
	420	450	480	525



PRECIO | PRICE | PRIX

ADL 190	7.180,00€
ADL 220	7.440,00€
ADL 250	7.800,00€
ADL 300	8.650,00€

ADDL • CANADIAN

SEGADORA DE HIERBA CON DOBLE DISCO LATERAL PARA LA VARIACIÓN DE ANCHO DE CORTE

La segadora de hierba con doble disco lateral modelo S.H.A.S. es un producto de alta calidad, compacta, robusta y con una superficie lisa que garantiza la máxima fiabilidad y exigencia en cualquier campo. Sus dos brazos laterales garantizan el ajuste de la amplitud de trabajo y su ancho de trabajo es ajustable hidráulicamente de forma continua. La transmisión básica de la máquina es de cajas de engranajes. Es una máquina equipada con rodillos delanteros y grandes rodillos traseros (Ø 200 mm) de altura ajustable. Los discos deslizantes (libres en cojinetes) montados debajo los brazos laterales y libremente movibles (arriba y abajo) proporcionan una adaptación óptima a la irregularidad del terreno. El tercer punto con cadena flotante permite a la máquina seguir perfectamente en el suelo. *Para el funcionamiento de esta máquina, el tractor necesita DOS unidades de control de doble acción.*

Opcional

- El ajuste de la caja de cambios es a 540 RPM y podría ser a 750/1000 RPM siempre bajo pedido.
- La máquina está diseñada para ser conectada detrás del tractor y se utiliza en sendero. El montaje frontal o para tractores con conducción de marcha atrás se puede pedir siempre bajo pedido, indicando las RPM y la dirección de rotación del PTO).

- Ruedas neumáticas opcional

GRASS MOWER WITH DOUBLE SIDE DISC FOR VARIABLE CUTTING WIDTH

The Grass Mower with double side disc S.H.A.S. is a high quality product with a compact, robust design and a smooth surface that guarantees maximum reliability and demands on any type of field. Its two lateral arms guarantee the adjustment of the amplitude of work and its working width is hydraulically adjustable in continuous form. The basic transmission of the machine is through gearboxes. The S.H.A.S. is equipped with front rollers and large rear rollers (Ø 200 mm) of adjustable height. The sliding discs (free of bearings) are mounted under the lateral arms and are freely movable (up and down) which provide the machine with an optimal adaptation to irregular terrains. The 3rd point with floating chain allows the machine to perfectly maintain itself on the ground. *To operate this machine, the tractor requires TWO double action control units.*

Optional

- Gearbox standard setting is at 540 RPM but can be at 750/1000 on request.
- The S.H.A.S. is designed to be connected behind the tractor and is used following the tractor's trail. There is the possibility to adapt it to front-mount or for tractors with reverse drive, but always on request and indicating the RPM and the rotation sense of the PTO.
- Optional pneumatic wheels



TONDEUSE À GAZON AVEC DISQUE DOUBLE FACE POUR LA VARIATION DE LA LARGEUR DE COUPE





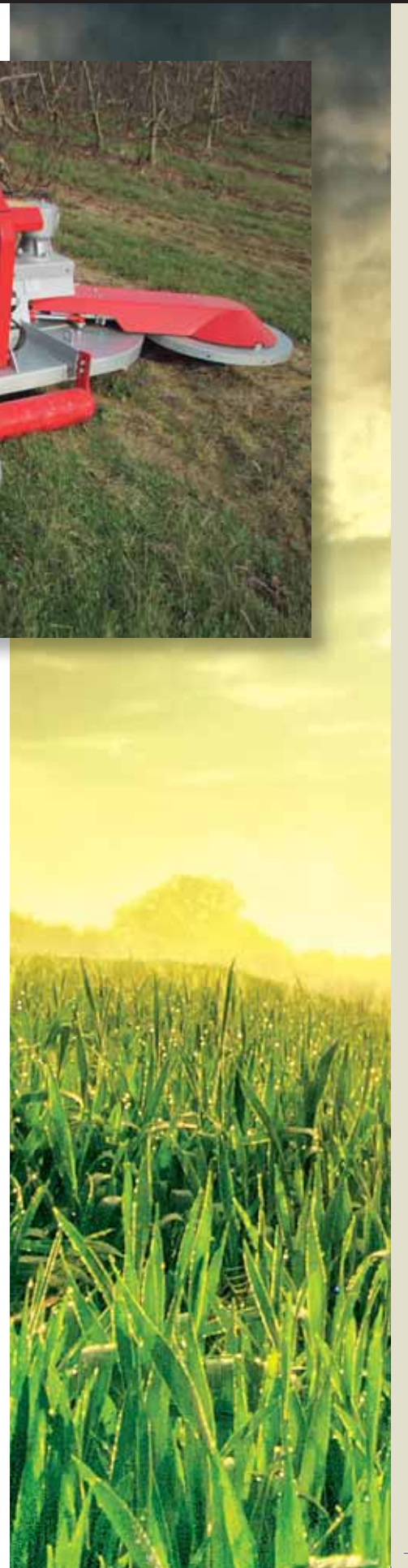

La tondeuse à gazon à disque double face modèle S.H.A.S. C'est un produit de haute qualité, compact, robuste et avec une surface lisse qui garantit une fiabilité et une demande maximales dans tous les domaines. Ses deux bras latéraux garantissent le réglage de la largeur de travail et sa largeur de travail est réglable hydrauliquement en continu. La transmission de base de la machine est les boîtes de vitesses. C'est une machine équipée de rouleaux avant et de grands rouleaux arrière (Ø 200 mm) de hauteur réglable. Les disques coulissants (libres dans les roulements) montés sous les bras latéraux et librement mobiles (dessus et dessous) assurent une adaptation optimale à l'irrégularité du terrain. Le troisième point avec chaîne flottante permet à la machine de suivre parfaitement le sol. *Pour le fonctionnement de cette machine, le tracteur a besoin de DEUX unités de commande à double action.*

En option

- Le réglage de la boîte de vitesses est à 540 tr / min et pourrait être à 750/1000 tr / min toujours sur demande.
- La machine est conçue pour être connectée derrière le tracteur et utilisée sur la piste. Le montage avant ou tracteur avec marche arrière peut toujours être commandé sur demande, en indiquant le régime et le sens de rotation de la prise de force).
- Roues pneumatiques en option



Modelos | Model | Modèle

	ADDL 342	ADDL 362	ADDL 392	ADDL 422
	345	365	395	425
	212-342	212-342	242-392	242-422
	4	4	4	4
	4	4	4	4
	45-80	45-80	45-80	55-90
	562	576	592	622



PRECIO | PRICE | PRIX

ADDL 342	14.188,00€
ADDL 362	14.335,00€
ADDL 392	14.740,00€
ADDL 422	15.745,00€

DL 650 • CUMBERLAND







ESTA DESMALEZADORA ES IDEAL PARA PLANTAS DE HUERTA Y TAMBIÉN SE PUEDE UTILIZAR PARA CONDICIONES DE TRABAJO COMO OBSTÁCULOS MUNICIPALES.

THIS GRINDER IS IDEAL FOR GARDEN PLANTS AND IT CAN ALSO BE USED FOR WORKING CONDITIONS AS MUNICIPAL OBSTACLES.

CE BROYEUR EST IDÉAL POUR LES PLANTES DE JARDIN ET IL PEUT ÉGALEMENT ÊTRE UTILISÉ POUR DES CONDITIONS DE TRAVAIL COMME OBSTACLES MUNICIPAUX.



Modelos | **Model** | **Modèle**

	DL 650
	1 N
Motor	14 m/r
	30-50
	140
	0.5 - 2 km/h

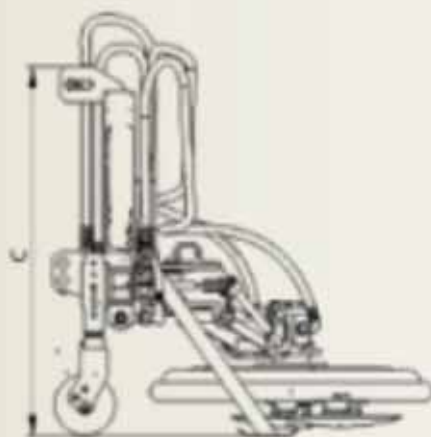
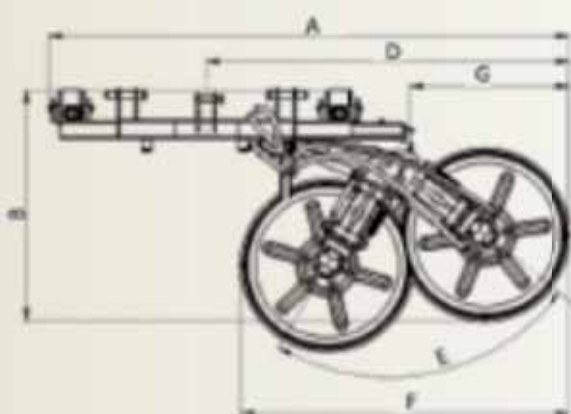

	A (mm)	B (mm)	C (mm)	D (mm)
DLB 410	2140-2570	950	935	1925-1500

PRECIO | **PRICE** | **PRIX**

DL 650 2.400,00€







Astilladoras forestales
Forest Wood chipper
Déchiqueteuse de bois

ATV 150 GASOLINA • OHIO























La ATV 150 es una astilladora compacta e innovadora surgida de las peticiones de nuestros clientes y tritura una gran diversidad de materiales (arbustos, ramas, residuos, maderas torcidas, troncos y ramas) con la mejor relación potencia - producción en serie.

The ATV 150 is a compact and innovative chipper that will fulfil our customer's requests. It can grind a wide variety of materials (shrubs, branches, debris, twisted wood, trunks and branches) with the best power-production ratio.

Le broyeur forestier ATV 150 est un broyeur compact et innovant qui répond aux demandes de nos clients. Il broie une grande variété de matériaux (arbustes, branches, résidus, bois torsadés, troncs et branches) avec le meilleur ratio de production en série.

Modelos | Model | **Modèle**

		ATV 150 GASOLINA	
	Ø Máx. tronco Ø Max. trunc Ø Max. tronc	mm	150
	Apertura de alimentación Feed opening size Ouverture d'alimentation	mm	150 - 250
	Ø Disco portacuchillas Blade disc Ø Disc porte-couteau	mm	620
	Nº Cuchillas de corte N.Cutting knives N. couteaux	Nº	4
	Producción horaria Chipping capacity Production horaire	m ²	4 - 8
	Peso Weight Poids	kg	690
	Dimensión boca alimentación Outer infeed opening dimensions Dimensions de l'ouverture extérieure	mm	760 x 1070
	Distancia boca alimentación al suelo Distance to infeed opening dimensions Distance nourrir la bouche au sol	mm	820
	Nº de rodillos alimentación N. of feed rollers N. de rouleaux d'alimentation	Nº	2
	Dimensiones astilla Chip dimensions Taille des casquetes	mm	5 - 12
	Giro tubo descarga Chip dimensions Rotation goulotte d'ejection	º	320
	Peso disco cuchillas Blade disc mass Poids disc porte-couteaux	kg	65
	Motor Engine Moteur GASOLINA/GASOLINE HONDA	CV / HP	22
	Velocidad disco Disk speed Vitesse du disque	RPM	1740
	Espesor de disco Disc's thickness Epaisseur du disque	mm	18
	Funcionamiento de serie Power control Opération en série		No stress
	Depósito combustible Fuel tank Réservoir de carburant	Lt	33
	Ruedas Wheel Roues + chasis 80 km/h		155 - 80 - 13
	Largura máx. Max. length Longueur max. Anchura máx. Max. width Largeur max. Altura máx. Max. height Hauteur max.	mm	3780 1550 254
	Sistema de seguridad / paros de emergencia Security system / emergency stoppages Système de sécurité / arrêts d'urgence	N	2
	Depósito aceite hidráulico Deposit hydraulic oil Dépôt huile hydraulique	Lt	20

PRECIO | PRICE | PRIX

ATV 150 GASOLINA

17.940,00€



ATV 155 DIÉSEL • PLATA



La ATV 155 es una astilladora que tritura un diámetro máximo de tronco de 155 mm de una gran diversidad de materiales (arbustos, ramas, residuos, maderas torcidas, troncos y ramas) con la mejor relación potencia - producción en serie. Con ella se alcanza una productividad de 4 a 10 m³/h.

The ATV 155 can grind a wide variety of materials (shrubs, branches, debris, twisted wood, trunks and branches) up to 155 mm diameter and offers the best power-production ratio. The ATV model can reach a productivity of 4 -10 m³/h.

ATV 155 broie un diamètre maximal de tronc de 155 mm à partir d'une grande variété de matériaux (arbustes, branches, résidus, bois torsadés, troncs et branches) avec le meilleur ratio de production en série. Avec cela, il atteint une productivité de 4 à 10 m³/h.



		Modelos Model Modèle	
		ATV 155 DIÉSEL	
	Ø máx. tronco Ø máx. trunc Ø max. tronc	mm	155
	Apertura de alimentació Feed opening size Ouverture d'alimentation	mm	155 - 250
	Ø disco portacuchillas Blade disc Ø disc porte-couteau	mm	620
	Núm. cuchillas de corte Cutting knives N. couteaux	Nº	4
	Producció horaria Chipping capacity Production horaire	m³	4-10
	Peso Weight Poids	kg	750
	Dimensió boca alimentació Outer infeed opening dimensions Dimensions de l'ouverture extérieure	mm	760x1070
	Distancia boca alimentació al suelo Distance to infeed opening to floor Distance de l'ouverture d'alimentation au sol	mm	820
	Núm. de rodillos alimentació Number of feed rollers Nombre de rouleaux d'alimentation	Nº	2
	Dimensiones astilla Chip dimensions Taille des casquettes	mm	5-12
	Giro tubo descarga Outlet hood rotation Rotation goulotte d'éjection	º	320
	Peso disco cuchillas Blade disc mass Poids disc porte-couteaux	kg	65
	Motor Engine Moteur KOHLER LDW 1003 DIÉSEL	CV / HP	24.5
	Velocidad disco Disk speed Epaisseur du disque	RPM	1.840
	Espesor de disco Disc's thickness Vitesse du disque	mm	18
	Sistema no stress No stress system Système no stress		No stress
	Depósito combustible Fuel tank Réservoir de carburant	Lt	33
	Ruedas Wheel Roues + chasis 80 km/h		155-80-13
	Largura máx. Max. length Longueur max.	mm	3.150
	Anchura máx. Max. width Largeur max.	mm	1.715
	Altura máx. Max. height hauteur max.	mm	1.635 + 930 (TUBO / TUBE)
	Sistema de seguridad / paros de emergencia Security system / emergency stoppages Système de sécurité / arrêts d'urgence	N	2
	Depósito aceite hidráulico Deposit hydraulic oil Dépôt huile hydraulique	Lt	20

PRECIO | PRICE | PRIX

ATV 155 DIÉSEL

22.990,00€



ATV 210 DIÉSEL • MISSOURI

























La ATV 210 es una astilladora de las más innovadoras del mercado que cumple con las peticiones de nuestros clientes. Tritura una gran diversidad de materiales (arbustos, ramas, residuos, maderas torcidas, troncos y ramas) con la mejor relación potencia-producción en serie. Con ella se alcanza una productividad de 8 a 14 m³/h.

The ATV 210 is the most innovative on the market that meets the requests of our customers. It crushes a wide variety of materials (shrubs, branches, residues, twisted woods, trunks and branches) with the best power - series production ratio. With it, it reaches a productivity of 8 to 14 m³/h.

Le ATV 210 est une déchiqueteuse et la plus innovante du marché qui répond aux demandes de nos clients. Il écrase une grande variété de matériaux (arbustes, branches, résidus, bois torsadés, troncs et branches) avec le meilleur ratio de production en série. Avec elle, il atteint une productivité de 8 à 14 m³/h.



			Modelos Model Modèle
			ATV 210 DIÉSEL
	Ø máx. tronco Ø máx. trunc Ø max. tronc	mm	210
	Apertura de alimentació Feed opening size Ouverture d'alimentation	mm	210-290
	Ø disco portacuchillas Disc's thickness Vitesse du disque	mm	885
	Espesor de disco Blade disc ø Epaisseur du disque	mm	32
	Núm. cuchillas de corte Cutting knives N. couteaux	Nº	4
	Producció horaria Chipping capacity Production horaire	m³	8-14
	Peso Weight Poids	kg	1.375
	Dimensió boca alimentació Outer infeed opening dimensions Dimensions de l'ouverture extérieure	mm	830x830
	Distancia boca alimentació al suelo Distance to infeed opening to floor Distance de l'ouverture d'alimentation au sol	mm	840
	Núm. de rodillos alimentació Number of feed rollers Nombre de rouleaux d'alimentation	Nº	2
	Dimensiones astilla Chip dimensions Taille des casquettes	mm	5-20
	Giro tubo descarga Outlet hood rotation Rotation goulotte d'éjection	º	320
	Peso disco cuchillas Blade disc mass Poids disc porte-couteaux	kg	188
	Motor Engine Moteur HATZ DIESEL	CV / HP	58
	Velocidad disco Disk speed Epaisseur du disque	RPM	1.840
	Espesor de disco Disc's thickness Vitesse du disque	mm	18
	Sistema no stress No stress system Système no stress		No stress
	Depósito combustible Fuel tank Réservoir de carburant	Lt	33
	Ruedas Wheel Roues + chasis 80 km/h		185-14-8 RP
	Largura máx. Max. length Longueur max.	mm	3.570
	Anchura máx. Max. width Largueur max.	mm	1.920
	Altura máx. Max. height hauteur max.	mm	1.745 + 930 (TUBO / TUBE)
	Sistema de seguridad / paros de emergencia Security system / emergency stoppages Système de sécurité / arrêts d'urgence	N	2
	Depósito aceite hidráulico Deposit hydraulic oil Dépôt huile hydraulique	Lt	20

PRECIO | PRICE | PRIX

ATV 210 DIÉSEL

36.490,00€



ATV 170 • ZAMBEZI



ASTILLADORA DE MADERA FORESTAL

La ATV 170 es una astilladora a tractor muy eficaz. Tritura un diámetro máximo de tronco de 170 mm de una gran diversidad de materiales (arbustos, ramas, residuos, maderas torcidas, troncos y ramas) con la mejor relación potencia - producción en serie. Con ella se alcanza una productividad de 4 a 10 m³/h.

FOREST WOOD CHIPPER TRACTOR

The ATV 170 is a very effective tractor chipper. It can grind a wide variety of materials (shrubs, branches, debris, twisted wood, trunks and branches) up to 170 mm diameter and offers the best power - production ratio. The ATV model can reach a productivity of 4 - 10 m³/h.

Le ATV 170 est une déchiqueteuse de tracteur très efficace. Peut broyer des troncs de 170 mm (max. diamètre) d'une grande variété de matériaux (branches, végétaux, résidus des bois, des scieries, feuilles, morceaux des bois tordu) avec le meilleur rapport puissance | production en série. La productivité obtenue est 4 - 10 m³/h.



			Modelos	Model	Modèle
			ATV 170		
	Ø máx. tronco Ø máx. trunc Ø max. tronc	mm	170		
	Apertura de alimentació Feed opening size Ouverture d'alimentation	mm	170 - 300		
	Ø disco portacuchillas Blade disc Ø disc porte-couteau	mm	745		
	Espesor de disco Disc's thickness Epaisseur du disque	mm	25		
	TFT Tractor TFT Tractor TFT Tracteur	RPM	540 - 1.000		
	Núm. cuchillas de corte Cutting knives N. couteaux	Nº	4		
	Producció horaria Chipping capacity Production horaire	m³	4-10		
	Peso Weight Poids	kg	655		
	Potencia CV tractor Power range tractor Puissance CV tracteur	Min/ Max	40-120		
	Dimensión boca alimentación Outer infeed opening dimensions Dimensions de l'ouverture extérieure	mm	920x600		
	Distancia boca alimentación al suelo Distance to infeed opening to floor Distance de l'ouverture d'alimentation au sol	mm	700		
	Acoplamiento tractor Mounting system Attelage du tracteur		Tres puntos y ruedas Three points and wheels Trois points et roues		
	Núm. de rodillos alimentación Number of feed rollers Nombre de rouleaux d'alimentation	Nº	2		
	Largura máx. Max. length Longueur max.	mm	2.280		
	Anchura máx. Max. width Largueur max.	mm	1.460		
	Altura máx. Max. height hauteur max.	mm	2.580		
	Dimensiones astilla Chip dimensions Taille des casquettes	mm	5-15		
	Sistema no stress No stress system Système no stress		Opcional Option En option		
	Alimentación hidráulica Hydraulic infeed Puissance hydraulique		Sistema hidráulico tractor Hydraulic system tractor Système hydraulique du tracteur		
	TFT rueda libre y embrague Freewheel included in the gearbox T.F.T. roue libre et embrayage		Incluida Included Inclus		
	Giro tubo descarga Outlet hood rotation Rotation goulotte d'éjection	º	320º		
	Peso disco cuchillas Blade disc mass Poids disc porte-couteaux	kg	97		
	Tiro con ruedas Towing with wheels Remorquage avec des roues		De serie Standard De serié		

PRECIO | PRICE | PRIX

ATV 170	10.780,00€
No stress con 2 paros de seguridad Emergency stoppages	2.286,00€



ATV 200 • MACKENZIE



ASTILLADORA DE MADERA FORESTAL

La ATV 200 es una astilladora a tractor desarrollada para triturar un diámetro máximo de tronco de 200 mm de una gran diversidad de materiales (arbustos, ramas, residuos, maderas torcidas, troncos y ramas) con la mejor relación potencia - producción en serie. Con ella se alcanza una productividad de 8 a 14 m³/h.

FOREST WOOD CHIPPER TRACTOR

The ATV 200 is a chipper to tractor developed for grind a wide variety of materials (shrubs, branches, debris, twisted wood, trunks and branches) up to 200 mm diameter and offers the best power - production ratio. The ATV model can reach a productivity of 8 - 14 m³/h.

La A.T.V 200 est une déchiqueteuse au tracteur développé pour broyer des troncs de 200 mm (max. diamètre) d'une grande variété de matériaux (branches, végétaux, résidus des bois, des scieries, feuilles, morceaux des bois tordu) avec le meilleur rapport puissance/production en série. La productivité obtenue est 8 - 14 m³/h.



			Modelos	Model	Modèle
			ATV 200		
	Ø máx. tronco Ø máx. tronc Ø max. tronc	mm	200		
	Apertura de alimentació Feed opening size Ouverture d'alimentation	mm	200-290		
	Ø disco portacuchillas Blade disc Ø disc porte-couteau	mm	885		
	Espesor de disco Disc's thickness Epaisseur du disque	mm	32		
	TFT Tractor TFT Tractor TFT Tracteur	RPM	540 - 1.000		
	Núm. cuchillas de corte Cutting knives N. couteaux	Nº	4		
	Producció horaria Chipping capacity Production horaire	m³	8-10		
	Peso Weight Poids	kg	780		
	Potencia CV tractor Power range tractor Puissance CV tracteur	Min/ Max	50-120		
	Dimensión boca alimentación Outer infeed opening dimensions Dimensions de l'ouverture extérieure	mm	830x830		
	Distancia boca alimentación al suelo Distance to infeed opening to floor Distance de l'ouverture d'alimentation au sol	mm	790		
	Acoplamiento tractor Mounting system Attelage du tracteur		Tres puntos y ruedas Three points and wheels Trois points et roues		
	Núm. de rodillos alimentación Number of feed rollers Nombre de rouleaux d'alimentation	Nº	2		
	Largura máx. Max. length Longueur max.	mm	2.650		
	Anchura máx. Max. width Largeur max.	mm	1.460		
	Altura máx. Max. height hauteur max.	mm	2.410		
	Dimensiones astilla Chip dimensions Taille des casquettes	mm	5-20		
	Sistema no stress No stress system Système no stress		Opcional Option En option		
	Alimentación hidráulica Hydraulic infeed Puissance hydraulique		Sistema hidráulico tractor Hydraulic system tractor Système hydraulique du tracteur		
	TFT rueda libre y embrague Freewheel included in the gearbox T.F.T. roue libre et embrayage		Incluida Included Inclus		
	Giro tubo descarga Outlet hood rotation Rotation goulotte d'éjection	º	320º		
	Peso disco cuchillas Blade disc mass Poids disc porte-couteaux	kg	188		
	Tiro con ruedas Towing with wheels Remorquage avec des roues		De serie Standard De sérié		

PRECIO | PRICE | PRIX

ATV 200 TFT	12.100,00€
No stress con 2 paros de seguridad Emergency stoppages	2.286,00€



ATV 260 • MISSISSIPPI





















La ATV 260 es la astilladora más profesional y robusta de esta gama y cumple con los requisitos de los clientes más exigentes. Se presenta en dos opciones: en sistema hidráulico del tractor o bomba incluida. Tritura un diámetro máximo de tronco de 260 mm con la mejor relación potencia - producción en serie. Con ella se alcanza una productividad de 7 a 30 m³/h.

The ATV 260 is a chipper most professional and robust of this range and fulfil with the requirements of the most demanding customers. It is presented in two options: in hydraulic system of the tractor or pump included. It can grind a wide variety of materials (shrubs, branches, debris, twisted wood, trunks and branches) up to 260 mm diameter and offers the best power - production ratio. The ATV model can reach a productivity of 7 - 30 m³/h.

La Déchiqueteuse de bois A.T.V 260 est le plus professionnel et robuste de cette gamme et a été conçue pour les clients les plus exigeants. Nous offrons la machine avec pompe hydraulique inclus ou avec le système hydraulique du tracteur. Ce model peut broyer des troncs de 260 mm (max. diamètre) avec le meilleur rapport puissance / production en série. La productivité obtenue est 7 - 30 m³/h.



			Modelos Model Modèle
			ATV 260
	Ø máx. tronco Ø máx. trunc Ø max. tronc	mm	260
	Apertura de alimentació Feed opening size Ouverture d'alimentation	mm	260 - 260
	Ø disco portacuchillas Blade disc Ø disc porte-couteau	mm	980
	Espesor de disco Disc's thickness Epaisseur du disque	mm	38
	RPM disco Cutting disc speed RPM disc	RPM	540 - 1.000
	Núm. cuchillas de corte Cutting knives N. couteaux	Nº	4
	Producció horaria Chipping capacity Production horaire	m³	7 - 30
	Peso Weight Poids	kg	855
	Potència CV tractor Power range tractor Puissance CV tracteur	Min/ máx	50 - 130
	Dimension boca alimentación Outer infeed opening dimensions Dimensions de l'ouverture extérieure	mm	930 x 1.000
	Distancia boca alimentación al suelo Distance to infeed opening to floor Distance de l'ouverture d'alimentation au sol	mm	580
	Acoplamiento tractor Mounting system Attelage du tracteur		Tres puntos y ruedas Three points and wheels Trois points et roues
	Núm. de rodillos alimentación Number of feed rollers Nombre de rouleaux d'alimentation	Nº	2
	Largura máx. Max. length Longueur max.	mm	3.000
	Anchura máx. Max. width Largueur max.	mm	2.900
	Altura máx. Max. height hauteur max.	mm	1.820
	Dimensiones astilla Chip dimensions Taille des casquettes	mm	5 - 30
	Sistema no stress No stress system Système no stress		Opcional Option En option
	Alimentación hidráulica Hydraulic infeed Puissance hydraulique		Sistema hidráulico tractor Hydraulic system tractor Hydraulique du tracteur
	TFT rueda libre y embrague Freewheel included in the gearbox T.F.T. roue libre et embrayage		Incluida Included Inclus
	Giro tubo descarga Outlet hood rotation Rotation goulotte d'éjection	º	320º
	Peso disco cuchillas Blade disc mass Poids disc porte-couteaux	kg	240

PRECIO | PRICE | PRIX

ATV 260	23.085,00€
No stress con 2 paros de seguridad Emergency stoppages	2.286,00€



ATV 100 • TENNESSEE



ASTILLADORA DE MADERA FORESTAL

La ATV 100 es una astilladora muy compacta. Tritura un diámetro máximo de tronco de 100 mm de una gran diversidad de materiales (arbustos, ramas, residuos, maderas torcidas, troncos y ramas) con la mejor relación potencia - producción en serie. Con ella se alcanza una productividad de 2 a 6 m³/h.



















FOREST WOOD CHIPPER TRACTOR

The ATV 100 model is a chipper very compact. It can grind a wide variety of materials (shrubs, branches, debris, twisted wood, trunks and branches) up to 100 mm diameter and offers the best power-production ratio. The ATV model can reach a productivity of 2 - 6 m³/h.

DÉCHIEQUETEUSE AU TRACTEUR

La A.T.V 100 est une déchiqueteuse très compact. Peut broyer des troncs de 100 mm (max. diamètre) d'une grande variété de matériaux (branches, végétaux, résidus des bois, des scieries, feuilles, morceaux des bois tordu) avec le meilleur rapport puissance/production en série. La productivité obtenue est 2 - 6 m³/h.



			Modelos	Model	Modèle
			ATV 100		
	Ø máx. tronco Ø máx. trunc Ø max. tronc	mm	100		
	Apertura de alimentació Feed opening size Ouverture d'alimentation	mm	100x165		
	Ø disco portacuchillas Blade disc Ø disc porte-couteau	mm	620		
	Espesor de disco Disc's thickness Epaisseur du disque	mm	18		
	TFT Tractor TFT Tractor TFT Tracteur	RPM	540 - 1.000		
	Núm. cuchillas de corte Cutting knives N. couteaux	Nº	4		
	Producció horaria Chipping capacity Production horaire	m³	2-6		
	Peso Weight Poids	Kg	290		
	Potencia tractor Power range tractor Puissance tracteur (CVI HP)	Min/ máx	15-50		
	Dimensión boca alimentación Outer infeed opening dimensions Dimensions de l'ouverture extérieure	mm	500x500		
	Distancia boca alimentación al suelo Distance to infeed opening to floor Distance de l'ouverture d'alimentation au sol	mm	1.170		
	Acoplamiento tractor Mounting system Attelage du tracteur		Tres puntos Three points Trois points		
	Largura máx. Max. length Longueur max.	mm	2.130		
	Anchura máx. Max. width Largueur max.	mm	860		
	Altura máx. Max. height hauteur max.	mm	1.460		
	Dimensiones astilla Chip dimensions Taille des casquetes	mm	5-12		
	TFT rueda libre y embrague Freewheel included in the gearbox T.F.T. roue libre et embrayage		Incluida Included Inclus		
	Giro tubo descarga Outlet hood rotation Rotation goulotte d'éjection	º	320º		
	Peso disco cuchillas Blade disc mass Poids disc porte-couteaux	kg	70		



PRECIO | PRICE | **PRIX**

ATV 100

6.000,00€

ATV 120 • LIMPOPO



ASTILLADORA DE MADERA FORESTAL



















La Astilladora de Madera Forestal ATV 120 tritura un diámetro máximo de tronco de 120 mm de una gran diversidad de materiales (arbustos, ramas, residuos, maderas torcidas, troncos y ramas) con la mejor relación potencia - producción en serie. Con ella se alcanza una productividad de 4 a 8 m³/h.

FOREST WOOD CHIPPER TRACTOR

The ATV 120 model can grind a wide variety of materials (shrubs, branches, debris, twisted wood, trunks and branches) up to 120 mm diameter and offers the best power-production ratio. The ATV model can reach a productivity of 4 – 8 m³/h.

La Déchiqueteuse de bois A.T.V 120 peut broyer de troncs de 120 mm (max. diamètre) d'une grande variété de matériaux (branches, végétaux, résidus des bois, des scieries, feuilles, morceaux des bois tordu) avec le meilleur rapport puissance/production en série. La productivité obtenue est 4 - 8 m³/h.



			Modelos Model Modèle
			ATV 120
	Ø máx. tronco Ø máx. trunc Ø max. tronc	mm	120
	Apertura de alimentació Feed opening size Ouverture d'alimentation	mm	120 x 165
	Ø disco portacuchillas Blade disc Ø disc porte-couteau	mm	620
	Espesor de disco Disc's thickness Epaisseur du disque	mm	18
	TFT Tractor TFT Tractor TFT Tracteur	RPM	540 - 1.000
	Núm. cuchillas de corte Cutting knives N. couteaux	Nº	4
	Producció horaria Chipping capacity Production horaire	m³	4-8
	Peso Weight Poids	Kg	340
	Potencia CV tractor Power range tractor Puissance CV tracteur	Min/ máx	20/50
	Dimensión boca alimentación Outer infeed opening dimensions Dimensions de l'ouverture extérieure	mm	500x500
	Distancia boca alimentación al suelo Distance to infeed opening to floor Distance de l'ouverture d'alimentation au sol	mm	1.140
	Acoplamiento tractor Mounting system Attelage du tracteur		Tres puntos Three points Trois points
	Largura máx. Max. length Longueur max.	mm	2.130
	Anchura máx. Max. width Largueur max.	mm	940
	Altura máx. Max. height hauteur max.	mm	1.865
	Alimentación hidráulica Hydraulic infeed Puissance hydraulique		Sistema hidráulico tractor Hydraulic system tractor Système hydraulique du tracteur
	Dimensiones astilla Chip dimensions Taille des casquettes	mm	5-12
	TFT rueda libre y embrague Freewheel included in the gearbox T.F.T. roue libre et embrayage		Incluida Included Inclus
	Giro tubo descarga Outlet hood rotation Rotation goulotte d'éjection	º	320º
	Peso disco cuchillas Blade disc mass Poids disc porte-couteaux	kg	70



PRECIO | PRICE | PRIX

ATV 120

7.490,00€

ATV 100 GASOLINA • HUDSON



La ATV 100 con motor gasolina es una astilladora muy compacta. Tritura un diámetro máximo de tronco de 100 mm de una gran diversidad de materiales (arbustos, ramas, residuos, maderas torcidas, troncos y ramas) con la mejor relación potencia - producción en serie. Con ella se alcanza una productividad de 2 a 6 m³/h.

The ATV 100 model with gasoline engine is a chipper very compact. It can grind a wide variety of materials (shrubs, branches, debris, twisted wood, trunks and branches) up to 100 mm diameter and offers the best power - production ratio. The ATV model can reach a productivity of 2 - 6 m³/h.

La A.T.V 100 et à moteur essence est une déchiqueteuse très compact. Peut broyer des troncs de 100 mm (max. diamètre) d'une grande variété de matériaux (branches, végétaux, résidus des bois, des scieries, feuilles, morceaux des bois tordu) avec le meilleur rapport puissance/ production en série. La productivité obtenue est 2 - 6 m³/h.



Modelos | Model | **Modèle**

ATV 100 GASOLINA

	Ø máx. tronco Ø máx. trunc Ø max. tronc	mm	100
	Apertura de alimentació Feed opening size Ouverture d'alimentation	mm	100 x 165
	Ø disco portacuchillas Blade disc Ø disc porte-couteau	mm	620
	Espesor de disco Disc's thickness Epaisseur du disque	mm	18
	Núm. cuchillas de corte Cutting knives N. couteaux	Nº	4
	Producció horaria Chipping capacity Production horaire	m³	2 - 6
	Peso Weight Poids	kg	390
	Motor Engine Moteur HONDA GX630RH QZ E4 GASOLINA	CV / HP	22
	Dimensió boca alimentació Outer infeed opening dimensions Dimensions de l'ouverture extérieure	mm	500 x 500
	Distància boca alimentació al sòl Distance to infeed opening to floor Distance de l'ouverture d'alimentation au sol	mm	1.170
	Tiro con ruedas Towing with wheels Remorquage avec des roues		De serie Standard De série
	Largura máx. Max. length Longueur max.	mm	1.800
	Anchura máx. Max. width Largueur max.	mm	1.530
	Altura máx. Max. height hauteur max.	mm	2.060
	Dimensiones astilla Chip dimensions Taille des casquettes	mm	5-12
	Giro tubo descarga Outlet hood rotation Rotation goulotte d'éjection	º	320º
	Peso disco cuchillas Blade disc mass Poids disc porte-couteaux	kg	70



PRECIO | PRICE | **PRIX**

ATV 100 GASOLINA

10.340,00€

ATV 400-650 T • DARLING





La astilladora ATV 400-650T tritura arbustos, ramas, astas, refiles de aserraderos, costaneras, láminas, cáscara, maderas torcidas, troncos y ramas con la mejor relación potencia y producción en serie. Puede ser alimentado por grúa y/o manualmente.

The Forest Wood Chipper ATV 400-650T chips easily shrubs, branches, sawmill, slabs, plates, shells, wood crooked trunks and logs. Can be supplied by crane and / or manually.

La Déchiqueteuse de bois ATV permet broyer des branches, végétaux, résidus des bois, des scieries, feuilles, morceaux des bois tordu. Il peut être alimenté manuellement ou par une grue.



			Modelos Model Modèle
			ATV 400-650 T
	Apertura de entrada vertical Vertical inlet opening Ouverture d'entrée verticale	mm	410
	Ancho de entrada horizontal Horizontal input length Largueur horizontale de l'ouverture	mm	650
	Ø de corte máximo Ø Maximum cutting Ø maximale de coupe	mm	410
	Producción Production Production	m ³	40 - 70
	Criba estándar Standard screen Grille standard	mm	70 x 70
	Ø del rulo de tracción Ø Drive roller Ø du rouleau d'entraînement	mm	300
	Ø de tambor Ø Drum Ø de tambour	mm	560
	Nº cuchillas Nº blades Couteaux		8
	Longitud cinta alimentación Feed conveyor length Longueur du tapis d'alimentation	mm	1.600
	Tamaño de la astilla Size of the chip Taille des plaquettes	mm	20 - 40
	Accionamiento Drive Actionnement	RPM	1.000
	Potencia requerida tractor Tractor power required Puissance du tracteur nécessaire	CV / HP	90 - 160
	Rotación máxima Maximum rotation Rotation maximale	°	365
	Tanque aceite hidráulico Hydraulic oil tank Réservoir d'huile hydraulique	Lt	60
	Control de alimentación Power control Contrôle puissance		No stres
	Tubo de descarga Discharge tube Goulotte d'éjectiion		270° plegable y ajustable
	Altura de descarga de astilla Height of discharge of chip Hauteur de chargement des copeaux	mm	4.000
	Dimensiones Size Dimensions	mm	3.500 x 2.450 x 3.400
	Velocidad de transporte Transport speed Vitesse du transport	km/h	40
	Neumáticos Wheels Roues		11.5/80 - 15.3
	Peso Weight Poids	kg	5.600

- El tambor multicuchillas permite el triturado homogéneo y de alta calidad de una variedad de maderas.
 - El innovador sistema de extracción de los chips hace la astilladora ágil y compacta.
 - El accionamiento por la toma de fuerza del tractor reduce la inversión.
 - Optimo para quien precisa de movilidad, sin salir de la alta capacidad
- Su exclusivo chasis permite un regulado da la altura de la estera, facilitando el trabajo del operador.

- The multi-knives drum allows homogeneous and high quality chipping of a great variety of woods.
 - The innovative extraction system makes this chipper compact and agile.
 - Reduces investment as it is driven by the tractor's power take-off
 - Suitable for anyone who requires more mobility without giving-up high capacity.
- Its unique frame allows bell height adjustment, and makes work easier for the operator.

- Le tambour à lames multiples permet un broyage uniforme d'haute qualité et d'une grande variété de bois.
 - Le système innovant d'extraction facilite l'agilité et rend la machine plus compacte.
 - Optimal pour qui a besoin de mobilité, sans réduire la capacité.
- Son châssis exclusif permet un réglage en hauteur du tapis et facilite le travail de l'opérateur.

PRECIO | PRICE | PRIX

ATV 400-650 T

108.000,00€



1320 • CASTOR



ASTILLADORA TRITURADORA POLIVALENTE

Astilladoras profesionales para altas producciones con accionamiento con motor diesel de 400 a 500 cv montado sobre chasis y tirado por camión y a tractor. La astilladora y trituradora Castor 1320 se consolida como la máquina ideal para producir chips para biomasa y para la reducción de volumen y reciclaje. Al ser una máquina polivalente debido a que lleva un rotor con cuchillas o bien martillos de widea intercambiables, nos permite RECICLAR todo tipo de materiales como raíces, cepas, todo tipo de árboles y podas de jardinería en ciudades con grandes volúmenes con una alta productividad y excelente acabado.

MULTIPURPOSE SHREDDER CHIPPER

Professional wood chipper suitable for high production rates driven by diesel engines (400 – 500 HP), mounted on chassis and carried by trucks or tractors. The Chipper/Shredder Castor is the ideal machine for producing wood chips for biomass and for volume reduction as well as recycling. It's a versatile machine that ensures high productivity and excellent results as it incorporates a rotor with exchangeable hammers or blades that allows the user to recycle all kinds of materials such as roots, strans, pruning gardens and all types of trees of larger cities.

DÉCHIQUETEUSE

Déchiqueteuse professionnelle à niveaux de productions élevés, avec moteur diesel 400 – 500 Cv, montée sur châssis remorquable par un tracteur ou camion. La déchiqueteuse et broyeur CASTOR 1320 se confirme comme une machine idéale pour produire un broyat pour biomasse et pour la réduction de volume et recyclage. C'est une machine polyvalente parce que peut inclure un rotor avec des lames ou avec de marteaux en widia interchangeable. Nous permet de recyclé tous les types de matériaux comme racines, branchages, tous les types de bois et tailles de jardinage en villes qui ont grands volumes avec productivité élevée et excellente finition.



Modelos | Model | **Modèle**

1320

Altura Height Hauteur	3,98 m
Anchura Width Largeur	2,5 m
Longitud Length Longueur	11,5 m
Peso Weight Poids	14.500 kg
Apertura de trabajo Infeed opening Goulotte de chargement	62x134 cm
Sobre On tandem wheels À roues	Ruedas tándem Tandem wheels Roues en tandem.
Rotor Rotor Rotor	Cuchillas y martillos con punta de widea y martillos con soldadura de diamante Blades, widea tipped hammers and diamond welded hammers Lames, marteaux Widea avec pointes au carbure de tungstène ou marteaux diamantés.
Suspensión Suspension Suspension	Mecánica por ballestas frenos neumáticos Mechanical leaf springs and air-brake system Mécanique à lames, freins pneumatiques.
Depósito de carburante Fuel tank Réservoir de carburant	300
Cadena de alimentación Feeding chain Entraîneur à chaînes	132x300 cm
Rodillo de alimentación Feeding roller Rouleau d'alimentation	132 cm, 50 cm Ø
Rodillo triturador Breaker roller Concassage	89x132 cm
Cuchillas o martillos Blades or hammers Lames o marteaux	32
Criba Screen Écran	40-60-80-90-100-120 mm
Contra cuchilla Counter-blade Contre couteaux	Regulable mecánicamente (2 posiciones) Adjustable mechanically (2 positions) Réglable mécaniquement (2 positions)
Autoalimentada Self feeding Alimentation	estándar standard
Mando control Remote control	Estándar Standard
Motor Engine Moteur	Scania 488 cv diesel Iveco 354 cv diesel Iveco 510 cv diesel.
Producción horaria Hourly production Production x heure	80x120 m³/h dependiendo del material a astillar 80x120 m³/h depending on the material to chip 80 à 120 m3/h selon la matière à déchiqueter.
Peso Weight Poids	5600 kg.



PRECIO | PRICE | PRIX

IVECO turbodiesel 354HP	262.210,00€
IVECO turbodiesel 510HP	266.120,00€
SCANIA turbodiesel 488HP	273.780,00€

Equipamiento de serie | Standard equipment | Équipement standard

· Apertura de trabajo Infeed opening Orifice d'introduction:	620 x 1.340mm
· Rotor de trituración Crushing rotor Rotor pour le broyage:	ø890 x 1.320mm
· 32 martillos o cuchillas con punta de widea 32 hammers or knives widea pointed 32 marteaux ou lames avec pointe de widea	
· Tolva de admisión con cinta metálica Infeed hopper with metallic ribbon Tremie d'alimentation avec ruban métallique	1.320 x 3.000mm
· Sistema de control de alimentación Infeed control system Système de contrôle d'alimentation:	NO-STRESS
· Con suspensión para 80Km/h With suspension for 80Km/h Avec suspension pour 80Km/h	

Opciones | Options | Options

Extensión para descarga a 4,5m de altura abatible hidráulicamente Hydraulic extension to discharge at 4,5m Extension hydraulique pour décharger à 4,5m	10.166,00€
--	------------



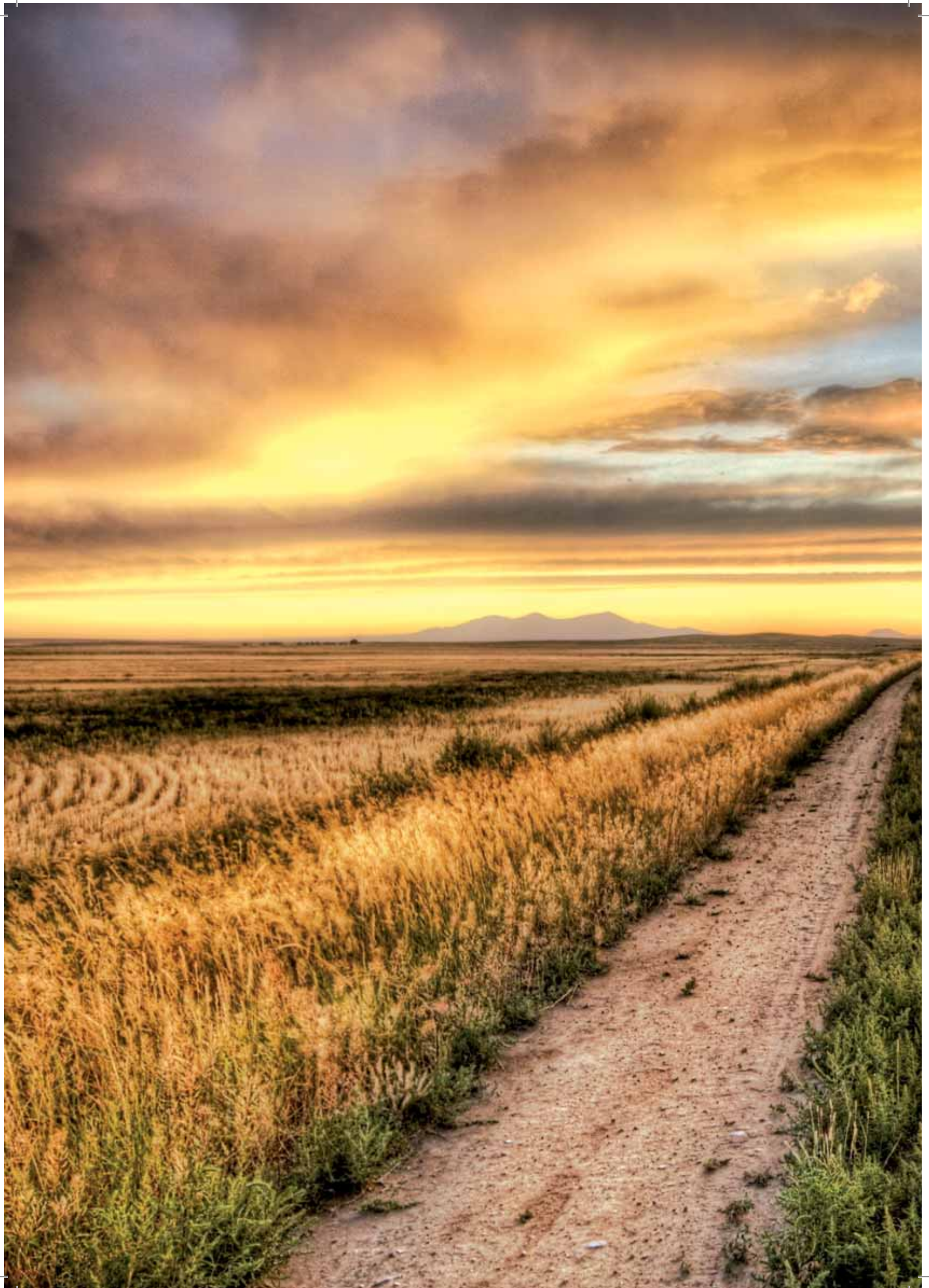



Hojas niveladoras
Graders
Lames nivelleuses

Ahoyadores
Post hole diggers
Tarières

NPH 250-300 • PARANÁ

HOJAS NIVELADORAS

La hoja niveladora NPH es la máquina ideal para hacer la nivelación de caminos, limpieza de cunetas, la realización de taludes y desplazar estiércol.

- Dispone de 3 movimientos hidráulicos a través del mando a distancia del tractor.
- El movimiento hidráulico vertical de la hoja niveladora.
- Movimiento hidráulico horizontal del árbol principal.
- Movimiento mecánico horizontal de la hoja niveladora. Opcionalmente puede ser hidráulico.
- Máquina de construcción muy robusta para tractores de 60 a 200 cv.
- Cuchilla de acero especial intercambiable.

GRADERS

The NPH Grader is the suitable machine for levelling roads, grading process, cleaning ditches, slope ground working and moving manure.









- Can have 3 hydraulic movements by the tractor's remote control unit.
- Dispone de 3 movimientos hidráulicos a través del mando a distancia del tractor.
- Inclining sheet with hydraulic ram.
- Hydraulic side movement of the driving shaft.
- Mechanical horizontal displacement of the blade. It can be hydraulic as option.
- Very strong built. Suitable for 60-200 HP tractors.
- Interchangeable steel blade

LAMES NIVELLEUSES

La NPH Grader est la machine appropriée pour le nivellement des routes, le nettoyage des fossés, travail des pentes et le déplacement du fumier.

- Peut avoir 3 mouvements hydrauliques par la télécommande de l'unité de tracteur.
- Mouvement hydraulique vertical de la lame nivelleuse.
- Déplacement latéral hydraulique de l'arbre principal.
- Mouvement mécanique horizontal de la lame nivelleuse. Hydraulique en option.
- Machine de structure compacte et robuste pour tracteurs 60-200 CV.
- Lame en acier interchangeable.



		Modelos	Model	Modèle
		NPH 250	NPH 300	NPH 300
	Peso Weight Poids	614	655	655
	Ancho trabajo Working width Largeur travail	2500	3000	3000
	Ancho (mm) Width Largeur Altura (mm) Height Hauteur Largo Length Longeur	2500 1140 1800	3000 1140 1800	3000 1140 1800
	Potencia mín. (cv) Min. power (hp) Puissance min. (cv)	60	80	80
	Potencia máx. (cv) Max. Power (hp) Puissance max (cv)	170	200	200
	Presión Pressure Pression	180 kg	180 kg	180 kg
	Acción hidráulica Hydraulic drive Entrainement hydr.	1-Op.3	2-Op.3	2-Op.3
	Giro Turn Rotation	2h 1m op.3r hid	2 h 1m op. 3re hid	2 h 1m op. 3re hid



PRECIO | PRICE | PRIX

NPH 250	5.980,00 €
NPH 300	6.060,00 €

Opciones | Options | Options

Cilindro hidráulico para 3er movimiento Hydraulic cylinder for 3rd movement Cylindre hydraulique pour le 3ème mouvement Sólo para Only for Seulement pour NPH 250 - NPH 300	570,00 €
--	----------



NPHL - NPM - NM • MURRAY

NPHL 210-250

HOJA NIVELADORA POLIDOZER HIDRÁULICA DE TRES MOVIMIENTOS, 2 HIDRÁULICOS 1 MECÁNICO

- Movimiento hidráulico vertical de la hoja niveladora.
- Movimiento hidráulico horizontal de la columna o árbol principal version hidráulica.
- Movimiento mecánico horizontal de la hoja niveladora. Para tractores de 40 a 110 CV.

HYDRAULICAL MOVING THREE MOVEMENTS, 2 HYDRAULIC 1 MECHANIC

- Hydraulic vertical movement of the frame.
- Hydraulic side movement of the shaft frame with a hydraulic ram on the hydraulic version.
- Sheet turning with mechanical running. Suitable for tractors from 40 - 110 hp.

LAME NIVELEUSE POLLIDOZER HYDRAULIQUE AVEC TROIS MOUVEMENTS, 2 HYDRAULIQUES ET 1 MÉCANIQUE

- Mouvement hydraulique vertical de la lame nivelleuse.
- Mouvement hydraulique horizontal de l'arbre/bras principal version hydraulique.
- Mouvement mécanique horizontal de la lame nivelleuse. Pour tracteurs de 40 - 110 Cv.

NPM 210-250

MECÁNICA DE TRES MOVIMIENTOS, MANUALES

- Movimiento mecánico vertical de la hoja niveladora
- Movimiento mecánico horizontal de la columna o árbol principal
- Movimiento mecánico horizontal de la hoja niveladora
- Para tractores de 50 a 120 CV

MECHANICAL MOVING THREE MOVEMENTS, MANUALS

- Mechanical vertical movement of the gradual sheet
- Mechanical horizontal movement of the frame
- Sheet turning with mechanical running
- Available for tractors from 50 till 120 hp

LAME NIVELEUSE AVEC TROIS MOUVEMENTS MÉCANIQUES, MANUELS

- Mouvement mécanique vertical de la lame nivelleuse
- Mouvement mécanique horizontal de l'arbre/bras principal
- Mouvement mécanique horizontal de la lame nivelleuse
- Pour tracteurs de 50 - 120 Cv.

NM 130-150-180

DOS MOVIMIENTOS

- Movimiento mecánico vertical de la hoja niveladora
- Movimiento mecánico horizontal de la hoja niveladora
- Para tractores de 20 a 50 CV







TWO MOVEMENTS

- Mechanical vertical movement of the gradual sheet
- Mechanical horizontal movement of the gradual sheet
- Available for tractors from 20 till 50 hp

DEUX MOUVEMENTS

- Mouvement mécanique vertical de la lame nivelleuse
- Mouvement mécanique horizontal de la lame nivelleuse
- Pour tracteurs de 20 - 50 Cv.



		Modelos Model Modèle						
		NPHL 210	NPHL 250	NPM 210	NPM 250	NM 130	NM 150	NM 180
	Peso Weight Poids	555	555	525	602	105	115	150
	Ancho trabajo Working width Largeur travail	2100	2500	2100	2500	1300	1500	1800
	Ancho (mm) Width Largeur	2100	2500	2100	2500	1300	1500	1800
	Altura (mm) Height Hauteur	1330	1330	1330	1330	1110	1110	1110
	Largo Length Longueur	1530	1530	1530	1530	1110	1110	1110
	Potencia mín. (cv) Min. power (hp) Puissance min. (cv)	40	40	50	50	20	20	20
	Potencia máx. (cv) Max. Power (hp) Puissance max (cv)	110	110	120	120	50	50	50
	Presión Pressure Pression	180 kg	180 kg	-	-	-	-	-
	Acción hidráulica Hydraulic drive Entraînement hydr.	2	2	-	-	-	-	-
	Giro Turn Rotation	2 hid 1 mec	2 hid 1 mec	3 mec	3 mec	2 mec	2 mec	2 mec



PRECIO | PRICE | PRIX

NPHL 210	3.740,00 €
NPHL 250	3.795,00 €
NPM 210	3.175,00 €
NPM 250	3.263,00 €
NM 130	1.740,00 €
NM 150	1.825,00 €
NM 180	2.025,00 €



A - B/M - B/H - C/M - C/H • DARIA

AHOYADORES

POST HOLE DIGGERS | **TARIERES**

MODELO A: Centrado | Centered | **Centré**

MODELO B/M: Desplazable mecánico | Mechanical displacement | **Déplacement mécanique**

MODELO B/H: Desplazable Hidráulico | Hydraulic displacement | **Déplacement hydraulique**

MODELO C/M: Desplazable con inversor | Mechanical displacement with reverse gearbox | **Déplacement mécanique avec boîtier réversible**

MODELO C/H: Desplazable hidráulico con inversor | Hydraulic displacement with reverse gearbox | **Déplacement hydraulique avec inverseur**

BROCAS | DRILLS | **VRILLES** (Ø mm):
150 - 200 - 300 - 450 - 600 - 800

Altura | Height | **Hauteur**: 100 cm.



Opcionalmente | Optional | **En option**: 130-150 cm.

Acoplamiento | Linkage | **Attelage**: tres puntos | three points | **trois points**

Realiza el hoyo | Makes hole | **Fait des trous**: Perpendicular en cualquier inclinación del terreno con una profundidad de 40 a 160 cm | Creates a hole perpendicular to any kind of sloping terrain with a depth of 40 to 160 cm | **Perpendiculaires quel que soit l'inclinaison du terrain, profondeur de 40 à 160 cm**

Muelle | Spring | **Resort**: De gran dimensión que regula el hoyo perpendicular y evita vibraciones | Big spring to regulate the perpendicular hole and absorb the vibrations | **Surdimensionné pour percer perpendiculairement et éviter les vibrations**



		Modelos		Model	Modèle	
		A	B/M	B/H	C/M	C/H
	Peso Weight Poids	130	220	225	240	245
	Potència tractor (min-max) Tractor power (min-max) Puissance tracteur (min-max)	25	35	35	35	35



PRECIO | PRICE | PRIX

A	1.620,00 €
B/M	2.260,00 €
B/H	2.550,00 €
C/M	3.395,00 €
C/H	3.650,00 €

Opciones | Options | Options

Broca 1mt. De altura 1mt. Height drill Vrille d'1mt. D' haut		Recambio cuchilla para broca Spare blade for drill Lame de rechange pour vrille	
ø 150mm	358,00 €	ø 150mm	21,50 €
ø 200mm	435,00 €	ø 200mm	22,50 €
ø 300mm	595,00 €	ø 300mm	52,50 €
ø 450mm	841,00 €	ø 450mm	60,00 €
ø 600mm	990,00 €	ø 600mm	81,00 €
ø 800mm	1.725,00 €	ø 800mm	135,00 €
Tornillo Screw Vis			3,00 €
Puntera tip Pointe			68,00 €
Prolongación de 30cm Extension of 30cm Rallonge du 30cm			125,00 €
Prolongación de 50cm Extension of 50cm Rallonge du 50cm			132,00 €



BRPV • TÁMESIS

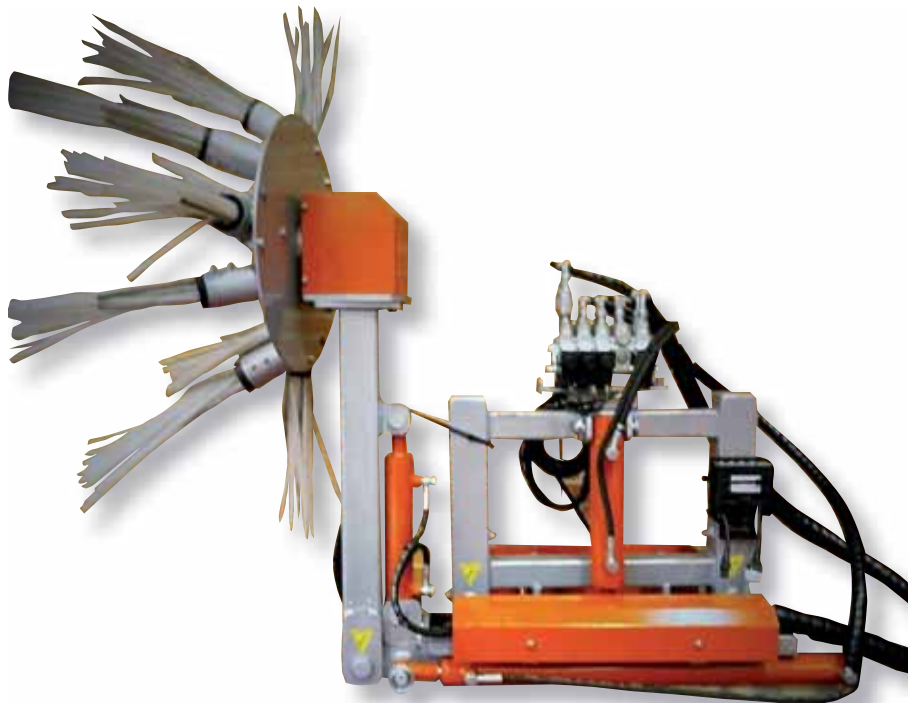

B.R.P.V. – TÁMESIS - BARREDORA DE RAMA DE PODA VENTURA

La barredora de rama de poda es uno de los complementos más eficaces para efectuar trabajos de acordonamiento para trituración de sarmiento de poda. Los cepillos hidráulicos pueden ser accionados en todos sus movimientos de forma hidráulica para ser instalados en la parte frontal del tractor. En el precio se incluye el mando a distancia del tractor en el modelo simple, y el mando eléctrico para el modelo doble, el regulador de caudal en motor, un motor hidráulico orbital, enganche rápido al tractor, disco de 6 brochas de 500mm y un soporte para su almacenamiento.



B.R.P.V. – TAMESIS - PRUNING BRANCH SWEEPER VENTURA

The pruning branch sweeper is one of the most effective complements to perform cordoning works for mulching pruning branches. The hydraulic bushes can be hydraulically driven in all their movements so that they can be installed in front of the tractor. Price includes remote control for the model simple and the electric controls for double model, engine flow regulator, orbital hydraulic motor, tractor quick coupling, 6-brush disc of 500 mm, and support for storage.

B.R.P.V. - TAMESIS - BALAI DE BRANCH DE BRANCH VENTURA

Le balai sécateur est l'un des compléments les plus efficaces pour effectuer des travaux de cordon afin d'écraser les branches d'élagage. Les balais hydrauliques peuvent être entraînés hydrauliquement dans tous leurs mouvements pour être installés à l'avant du tracteur. Le prix comprend la commande à distance du tracteur dans le modèle simple et la commande électrique pour le modèle double, le régulateur de débit du moteur, un moteur hydraulique orbital, une attache rapide au tracteur, des disques de 500 mm à 6 disques et support pour le stockage.



		Modelos	Model	Modèle
		BRPV SIMPLE		BRBP DOBLE
	Nº de platos Nº of plates Nombre d'assiettes	1		2
	Nº de cepillos Nº of brushes Nombre de brosses	6		6+6
	CV HP	16		30



PRECIO | PRICE | PRIX

BRPV SIMPLE	6.090,00 €
BRPV DOBLE	7.950,00 €

Opciones | Options | Options

Kit de 3 brochas horizontales Kit of 3 horizontal brushes Kit de 3 brosses horizontales	192,00 €
Kit placa enganche tractor Tractor coupling plate kit Kit de plaque d'attelage de tracteur	254,00 €
Repuesto tiras 6 cepillos Spare strips 6 brushes Bandes de rechange 6 brosses	155,00 €
Plato de 700 mm 700 mm plate Plaque 700 mm	98,00 €



Servicio post-venta
After-sales service
Service apres-vente

Disponemos de un amplio stock de recambios
We have a large stock of spare parts
Nous avons un grand stock de pièces de rechange



Nuestros proveedores
Our partners
Nos fournisseurs



Recambios | Spare parts | Pièces de rechange

CUCHILLA KNIFE LAME - CADENAS CHAINS CHAÎNES			
REFERENCIA REFERENC RÉFERENCE	DESCRIPCIÓN DESCRIPTION DÉSCRIPTION	PARA MÁQUINA FOR MACHINE POUR MACHINE	
CUCHILLA	Cuchilla knife Lame	Mod. 100A, 120A, 140A, 160A	Unit
		Mod. 180A, 200A 130F	Unit
		Mod. 270 AC, 360 AC	Unit
		Mod. 160F, 160SF	Unit
		Mod. 180F, 180SF	Unit
		Mod. 200F, 200SF	Unit
		Mod. 205 F2N, 220 F2N, 240 F2N, 260 F2N	Unit
		Mod. ACPL 280, ACPL 300, ACPL 320, ACPL 350, ACPL 400	Unit
		Mod. ACP 450-600	Unit
CADENA	Cadenas Chains Chaînes	Mod. 100A, 120A, 130A, 150A	Kit (ø13mm) (2 cadenas chains chaînes)
		Mod. 180A	Kit (ø16mm) (2 cadenas chains chaînes)
		Mod. 130F	Kit (ø16mm) (4 cadenas chains chaînes)
		Mod. 160F, 160SF	Kit (ø16mm) (4 cadenas chains chaînes)
		Mod. 180F, 180SF	Kit (ø16mm) (4 cadenas chains chaînes)
		Mod. 200F, 200SF	Kit (ø16mm) (4 cadenas chains chaînes)
		Mod. 205 F2N, 220 F2N,	Kit (ø16mm) (8 cadenas chains chaînes)
		Mod. 240 F2N, 260 F2N	Kit (ø19mm) (8 cadenas chains chaînes)
		Mod. DH 80	2 un (ø13 mm)
		Mod. DH 120	4 un (ø16 mm)
		Mod. DH 150	4 un (ø19 mm)

**MARTILLOS | HAMMERS | MARTEAUX
CUCHILLAS | KNIVES | LAMES**

010100001	Martillo móvil 360° 360° swinging hammer Marteau roulant 360° (1 sólo corte 1 cut 1 coupe)	Mod. TFVJ TFVJD TFVJH	
010100002	Martillo widia móvil 360° 360° swinging hammer widia Marteau widia roulant (1 sólo corte 1 cut 1 coupe)	Mod. TFVJ TFVJD TFVJH	
010100003	Martillo móvil 360° 360° swinging hammer Marteau roulant (Doble corte Double cut Double coupe)	Mod. TFVJ TFVJD TFVJH	
010500002	Martillos estrecho 360°G Strait hammer 360°G Déroit Marteau	Mod. TFV TFVD TFVH	
0101020001	Martillo oscilante Oscillating hammer Marteau oscillante (1 sólo corte 1 cut 1 coupe)	Mod. TFVJA TFVJAH	
010500001	Martillo móvil 360° 360° swinging hammer Marteau roulant (ancho, width, largeur)	Mod. TFV TFVD TFVH	
010800039	Martillo fijo con punta de widia Fixed widia hammer Marteau fixed du widia	Mod. TFVJMF TFVJMFD TFVMF TFVMFD TFMF TFVJMFH TFVMFH TFVLMFH	
010700050	Martillo fijo con punta de widia Fixed widia hammer Marteau fixed du widia	Mod. TFVJMF TFVJMFD TFVMF TFVMFD TFMF TFVJMFH TFVMFH TFVLMFH	
KFS 513P	Martillo recubrimiento especial Hammer with special coating Marteau revêtement spécial	Mod. CASTOR	
BFS 532	Martillo punta widea Hammer with widea tips Marteau pointe du widea	Mod. CASTOR	
KFS 101HT	Cuchilla Knife Lame	Mod. CASTOR	
MARTRISMX	Martillo móvil Swinging hammer Mart roulant	Mod. M TRIN MPT	
MARTRISML	Martillo móvil Swinging hammer Mart.roulant	Mod. ML	
MARTSF	Martillo móvil Swinging hammer Mart.roulant	TVA TSF TAV-O TSF-PTH TML-MCH	
MARTAV	Martillo móvil Swinging hammer Mart.roulant	Mod. TAV TRIN-R	

CRG053	Martillo móvil Swinging hammer Mart.roulant	TFVLHC TFVLIHM	
06100102	Cuchillas oscilantes Oscillating blades Lames oscillantes	TFVLHC TFVLIHM TRIN-R	
CUNM 130	Cuchilla Blade Lame polidozer	NM 130	
CUNM 150	Cuchilla Blade Lame polidozer	NM 150	
CUNM 180	Cuchilla Blade Lame polidozer	NM 180	
CUPH 200 X	Cuchilla Blade Lame polidozer	NPM 210 NPH 210	
CUPH 250 X	Cuchilla Blade Lame polidozer	NPHL 250 NPH 250 NPM 250	
CUPH 300	Cuchilla Blade Lame polidozer	NPH 300	
CUATV1	Cuchilla Blade Lame	ATV 100, 120	
CUATV15	Cuchilla Blade Lame	ATV 150	
CUATV2	Cuchilla Blade Lame	ATV 200	
CUATV26	Cuchilla Blade Lame	ATV 260	
CORREAS BELTS COURROIES			
XPB 1400	Correa Belt Courroie XPB 1400 (Antes Before Avant 08 2012)	Mod. TFVJ	Unit
XPB 1450	Correa Belt Courroie XPB 1450	Mod. TFVJ - TFVJMF - TFVJD TFVJMFD	Unit
XPB 1800	Correa Belt Courroie XPB 1800	Mod. TFV - TFVMF	Unit
XPB 1900	Correa Belt Courroie XPB 1900	Mod. TFVD - TFVMFD	Unit

Condiciones de venta | Sales condition | Conditions de vente

PRECIOS | PRICES | PRIX

Se facturarán los precios de la tarifa vigente pudiéndose modificar sin previo aviso. Estos precios son franco fábrica y no incluyen IVA.

The prices of the current price-list will be invoiced and may be modified without prior notice. These prices are ex works and do not include taxes.

Les prix de la liste de prix actuelle seront facturés et pourront être modifiés sans préavis. Ces prix Ex-Works et n'incluent pas les taxes.

ENVÍOS Y ENTREGAS | SHIPMENTS AND DELIVERIES | EXPÉDITIONS ET LIVRAISONS

Serán efectuados según instrucciones del comprador o de la forma más conveniente acordada entre ambas partes contratadas. La empresa no se hace responsable de cualquier agravio o pérdida de la mercancía durante el transporte. Los precios no incluyen embalajes.

They will be carried out according to the instructions of the buyer or in the most convenient way, in agreement between the parties contracted. The company is not responsible for any damages or loss of the merchandise during the transport. Prices do not include packaging.

Ils seront effectués selon les instructions de l'acheteur ou en accord entre les parties contractées. La compagnie n'est pas responsable des dommages ou perte de la marchandise pendant le transport. Les prix ne comprennent pas l'emballage.

GARANTÍA | WARRANTY TERMS | CONDITIONS DE GARANTIE

Dispone de un periodo de garantía de 1 año y que esta sólo incluye defectos de fabricación en la maquinaria o piezas defectuosas (no en la mano de obra). Quedando siempre a veredicto de la empresa si el defecto fue debido al mal uso o mala manipulación por parte del usuario. La garantía no incluye materiales sometidos a desgaste natural como cuchillas, contracuchillas, filtros, correas, poleas, neumáticos, etc.

1 Year Warranty. It only includes manufacturing defects in machinery or defective parts (not labour). Being provided to the verdict of the company if the flaw was due to misuse or mishandling by the user. The warranty does not include material subject to natural wear such as blades, counter blades, hammers, belts, pulleys, etc.

Période de garantie de 1 an et compris seulement les défauts de fabrication dans le machine ou les pièces défectueuses (pas de main-d'oeuvre). La société a le verdict de déterminer si le défaut est dû à une mauvaise utilisation ou une mauvaise manipulation par l'utilisateur. La garantie ne comprend pas du matériel soumis à une usure naturelle tels que les lames, les contre-lames, filtres, courroies, poulies, pneus, etc.

CONDICIONES DE PAGO | PAYMENT CONDITIONS | CONDITIONS DE PAIEMENT

La primera operación, salvo acuerdo entre comprador y vendedor, será al contado, y en lo sucesivo se utilizará la forma de pago acordada por la empresa y el cliente. En caso de pagos aplazados, la mercancía será propiedad de esta firma hasta que no se haya abonado el importe en su totalidad, gastos e intereses.

A pre-payment will be asked for the first transaction, except if there is any other agreement between the company and the customer. Thereafter the form of payment will be the one agreed by the company and the client. In case of deferred payments, the merchandise will be owned by the company until the amount has been fully paid with its expenses and interests.

Un prépaiement sera demandé pour la première transaction, sauf s'il existe un autre accord entre la société et le client. Par la suite, la forme de paiement sera celle convenue par la société et le client. En cas de paiement différé, la marchandise sera détenue par la société jusqu'à ce que le montant ait été entièrement payé avec ses frais et intérêts.

PLAZOS DE ENTREGA | DELIVERY TIME | TEMPS DE LIVRAISON

Sólo se indicarán las fechas a título informativo procurando no demorarlas, pero su incumplimiento no podrá ser causa de demanda por daños y perjuicios.

The delivery dates will be indicated only for information purposes, taking care not to delay them. However, its breach cannot be the cause of damage claims.

Les dates de livraison seront indiquées uniquement à titre d'information, en veillant à ne pas les retarder. Toutefois, sa violation ne peut pas être cause de réclamations de dommages.



Ventura

FORESTRY MACHINES

Ctra. Vilablareix, 18-20 (Pol. Ind. Mas Aliu)
17181 AIGUAVIVA (Girona-Spain)
+34 972 40 15 22 - +34 972 40 01 63
export@venturamaq.com
www.venturamaq.com

